

Operating Instructions

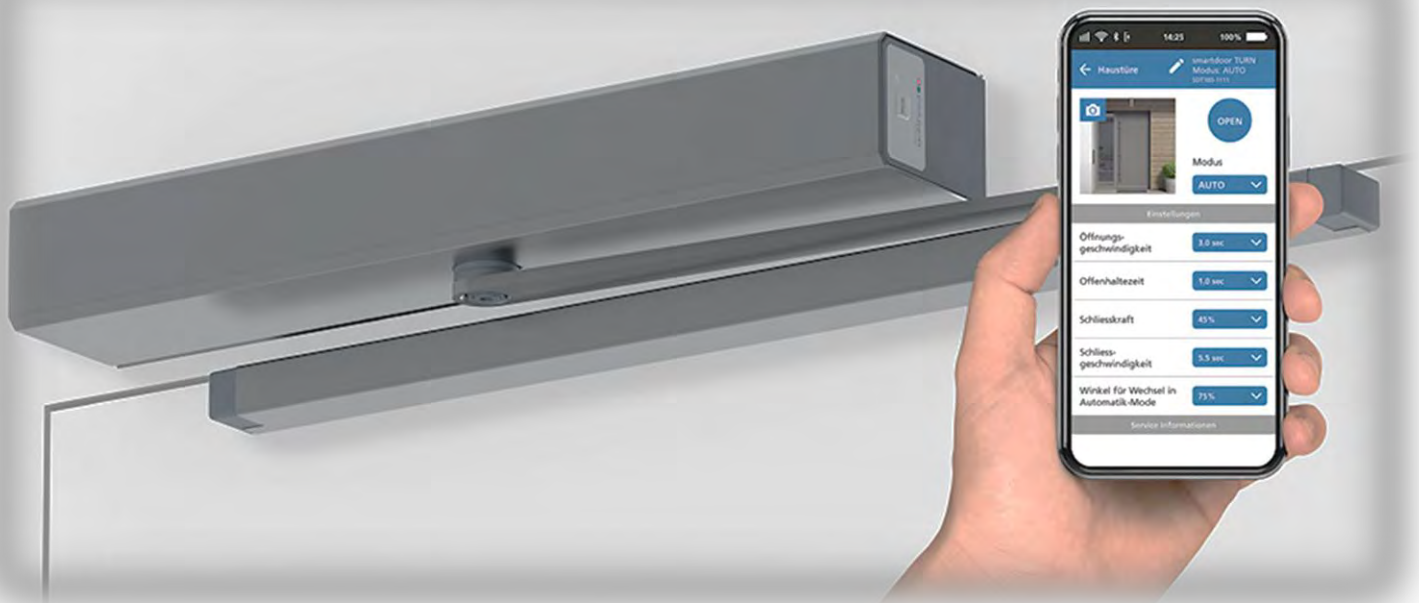

Swing Door Operator *smartdoor TURN T100*

Language: English



Table of contents

- 1 GENERAL INFORMATION..... 5
 - 1.1 PRODUCT IDENTIFICATION 5
 - 1.2 PRODUCT OVERVIEW..... 6
 - 1.2.1 THE BASIC MODULE 6
 - 1.2.2 THE LINKAGE..... 7
 - 1.2.3 THE OPERATING ELEMENTS..... 7
 - 1.2.4 THE SAFETY ELEMENTS 7
 - 1.2.5 THE DRIVE MODULE 7
 - 1.2.6 THE CONTROL MODULE 8
 - 1.2.7 THE COMMUNICATION MODULE 8
 - 1.2.8 THE SMARTDOOR SERVICE TOOL..... 9
 - 1.2.9 THE SMARTDOOR APP 9
- 2 SAFETY 10
 - 2.1 SYMBOLS AND DISPLAY OF WARNINGS 10
 - 2.2 STATE-OF-THE-ART AND APPLIED STANDARDS..... 10
 - 2.3 INTENDED USE 13
 - 2.4 LIMITATION OF LIABILITY 13
 - 2.5 USER GROUP 13
 - 2.6 RISK..... 13
 - 2.7 MISUSE..... 13
- 3 PRODUCT DESCRIPTION 15
 - 3.1 TERMS 15
 - 3.2 SWING DOOR TERMS..... 16
 - 3.3 LINKAGE TYPES 17
 - 3.4 HOLDING VARIANTS..... 20
 - 3.4.1 DOOR HANDLE WITH LATCH (WITH AND WITHOUT LOCK) 20
 - 3.4.2 DOOR HANDLE WITH BLOCKED LATCH (WITH AND WITHOUT LOCK)..... 20
 - 3.4.3 DOOR HANDLE WITH LATCH AND ELECTRIC DOOR OPENER 21
- 4 ASSEMBLY..... 22
 - 4.1 SAFETY DURING ASSEMBLY: 22
 - 4.2 MECHANICAL INSTALLATION 22
 - 4.2.1 MOUNTING PLATE 23
 - 4.2.2 ADAPTER PLATE..... 24
 - 4.2.3 ASSEMBLY LINKAGE 24
 - 4.2.4 LINKAGE DISASSEMBLY..... 25
 - 4.3 ELECTRIC INSTALLATION 26
 - 4.3.1 CONNECTION AC VERSION..... 26
 - 4.3.2 CONNECTION DC VERSION 26
 - 4.4 COMMISSIONING VIA AUTO-LEARNING FUNCTION..... 27
 - 4.4.1 FUNCTIONAL TEST (COMMISSIONING PUSH&Go)..... 27
 - 4.4.2 FUNCTIONAL TEST (AFTER INSTALLATION) 27
 - 4.4.3 HOLDING FORCE FUNCTIONAL TEST IN THE CASE OF CURRENT INTERRUPTION 27
 - 4.4.4 FUNCTION TEST (START AFTER CURRENT INTERRUPTION)..... 27
 - 4.5 COMMISSIONING OPERATING ELEMENTS..... 28
 - 4.5.1 BLUETOOTH OPERATING ELEMENTS 28
 - 4.5.1.1 ADDITION OF BLUETOOTH OPERATING ELEMENTS 28
 - 4.5.1.2 DELETING BLUETOOTH OPERATING ELEMENTS 29
 - 4.5.1.3 COMMISSIONING OF SMARTDOOR BLUETOOTH PUSH BUTTON 29
 - 4.5.1.4 COMMISSIONING OF SMARTDOOR BLUETOOTH MODULE (WITH PUSH BUTTON) 30
 - 4.5.1.5 ADDITION OF SMARTPHONE 31

4.5.2	WIRED OPERATING ELEMENTS	31
4.5.2.1	CONNECTION OF EXTERNAL CONTACTS	31
4.5.2.2	WIRED OPENING PULSES	31
4.5.2.3	COMMISSIONING WIRED PUSH BUTTON.....	31
4.5.2.4	COMMISSIONING WIRED RADAR	32
4.6	COMMISSIONING SAFETY ELEMENTS.....	32
4.6.1	COMMISSIONING SIO AND SIS PRESENCE SENSORS	33
4.6.1.1	CONNECTION SIO / SIS.....	33
4.6.1.2	TEST SIGNAL TEST	33
4.6.2	COMMISSIONING ELECTRIC DOOR OPENER (COM, NO AND NC).....	34
4.6.3	COMMISSIONING MOTOR LOCK (COM, NO AND NC AND MORE).....	35
4.6.4	COMMISSIONING DAY/NIGHT SWITCH-OVER.....	36
4.6.5	COMMISSIONING CLOSING SEQUENCE CONTROL (WIRED)	37
4.6.5.1	LOCKING THE STATIONARY LEAF:	38
4.6.5.2	INTERLOCKING THE TRAFFIC LEAF:	39
4.6.5.3	OPENING THE TRAFFIC LEAF ONLY:	39
4.6.5.4	SHOT BOLT OF STATIONARY LEAF:	39
4.6.6	COMMISSIONING AIRLOCK DOOR (WIRED).....	40
4.6.6.1	MUTUAL INTERLOCKING:	41
4.7	ESCAPE DOORS	42
4.8	FIRE DOORS.....	42
5	FUNCTIONS.....	43
5.1	AUTOMATIC SWITCH-ON FUNCTION AFTER POWER FAILURE	43
5.2	AUTOMATIC TROUBLESHOOTING FUNCTION.....	43
5.3	AUTO-LEARNING FUNCTION	44
5.3.1	PREREQUISITES	44
5.3.2	IMPLEMENTATION OF THE AUTO-LEARNING FUNCTION (WITH PROG KEY)	45
5.4	LOW-ENERGY MODE	46
5.5	FUNCTIONS OF INPUTS AND OUTPUTS	47
5.5.1	SIO: SAFETY SENSOR OPENING	47
5.5.2	SIS: SAFETY SENSOR CLOSING.....	47
5.5.3	OPENING PULSE (DAY+NIGHT)	47
5.5.4	OPENING PULSE (DAY+NIGHT) + LOCK FEEDBACK	47
5.5.5	OPENING PULSE (DAY)	47
5.5.6	DAY/NIGHT SWITCH-OVER.....	48
5.5.7	LOCK FEEDBACK	48
5.5.8	MODE SWITCH-OVER	48
5.6	CLOSING SEQUENCE CONTROL FUNCTION	48
5.7	AIRLOCK DOOR FUNCTION.....	48
6	OPERATING MODE	49
6.1	AUTOMATIC OPERATING MODE (LED: GREEN)	49
6.2	OPERATING MODE - CONTINUOUSLY OPEN (LED: FLASHING GREEN)	50
6.3	OPERATING STATUS INITIALISATION (LED: FLASHING ORANGE).....	50
6.4	AUTO-LEARNING OPERATING STATUS (LED: FLASHING RED/ORANGE).....	51
6.5	SYSTEM ERROR OPERATING STATUS (LED: FLASHING RED).....	51
7	OPERATION	52
7.1	MAIN SWITCH.....	52
7.2	SETTING THE HOLD-OPEN TIME	52
7.2.1	PROCESS	52
7.3	MANUAL RESET OF AN ERROR	53
7.3.1	PROCESS	53
7.4	SWITCHING OVER THE OPERATING MODE.....	53
7.4.1	SWITCH-OVER OF THE OPERATING MODE	53
7.5	SMARTDOOR APP	54
7.5.1	SYMBOLS.....	54

7.5.2	MAIN MENU - MY DOORS.....	55
7.5.3	CONNECT NEW DOOR OPERATOR IN THE APP.....	55
7.5.4	PASSWORD FOR RELEASE OF A SMARTPHONE.....	55
7.5.5	DOOR CONTROL.....	56
7.5.6	USER MANUAL / FAQ.....	57
8	SERVICE.....	58
8.1	CARE / OPERATOR CHECKS.....	58
8.1.1	SWITCH OFF.....	58
8.1.2	CHECKS.....	58
8.1.3	CARE.....	58
8.2	MAINTENANCE / INSPECTION BY TRAINED SPECIALIST PERSONNEL.....	58
9	TROUBLESHOOTING.....	59
9.1	RESET.....	59
9.1.1	PROCESS.....	59
10	TECHNICAL DATA.....	60
10.1	AREA OF USE AND OPENING TIMES IN LOW-ENERGY OPERATION.....	60
11	APPENDIX.....	62
11.1	CONNECTING TERMINALS.....	62
11.2	ASSIGNMENT OF FUNCTION TO INPUTS AND OUTPUTS.....	63
11.3	DISPLAY LED AND SYSTEM ERROR.....	64
11.3.1	COMMUNICATION MODULE.....	64
11.3.2	CONTROL MODULE.....	64
11.4	CONSTRUCTION PLANNER TEMPLATE – OBJECT OVERVIEW.....	66
11.5	CONSTRUCTION PLANNER TEMPLATE – ELECTRICAL DIAGRAM.....	67
11.6	ELECTRICAL DIAGRAMS.....	68
11.6.1	EXAMPLE ELECTRIC DOOR OPENER (MASTER).....	68
11.6.2	EXAMPLE ELECTRIC DOOR OPENER (MASTER WITH RELEASE) V1.....	69
11.6.3	EXAMPLE ELECTRIC DOOR OPENER (SLAVE).....	70
11.6.4	EXAMPLE CONVERSION OF ELECTRIC DOOR OPENER WITH INTERCOM SYSTEM (DC).....	71
11.6.5	EXAMPLE MOTOR LOCK (MASTER-MASTER).....	72
11.6.6	EXAMPLE MOTOR LOCK (MASTER-SLAVE).....	73
11.7	PUSH BUTTON TEMPLATE.....	74
11.8	AUTO-LEARNING FUNCTION.....	75

1 General information

1.1 Product identification

For precise identification the type plate attached to the control module is marked with the following details:

Company name:	Gotthard 3 Mechatronic Solutions AG Gotthardstrasse 3 CH – 5630 Muri (AG)																
Type:	smartdoor TURN T100																
Serial number:	e.g. 0100-01-01-01-20-0000-0535																
Reference number:	301010a (AC-version) 301011 (DC-version)																
Year of manufacture:	e.g. 2020																
Mains connection:	e.g. 100-240 V, 50/60 Hz																
Power consumption:	41 W																
Rated load:	30 Nm																
Admissible temperature range:	-15 °C to +50 °C																
Classified according to DIN 18650-1:	<table border="1" style="display: inline-table; border-collapse: collapse; text-align: center;"> <tr><td>1</td><td>2</td><td>3</td><td>4</td><td>5</td><td>6</td><td>7</td><td>8</td></tr> <tr><td>1</td><td>2</td><td>1</td><td>2*</td><td>2,3</td><td>0</td><td></td><td>2</td></tr> </table>	1	2	3	4	5	6	7	8	1	2	1	2*	2,3	0		2
1	2	3	4	5	6	7	8										
1	2	1	2*	2,3	0		2										
Installation firm:	(place holder for installation firm sticker)																

* Self-closing in combination with a battery

Photographic example:

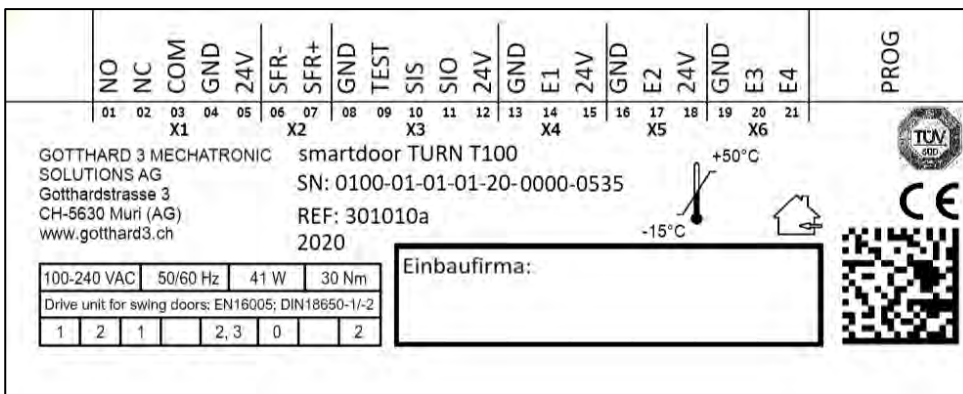

Figure 1: Product identification

1.2 Product overview

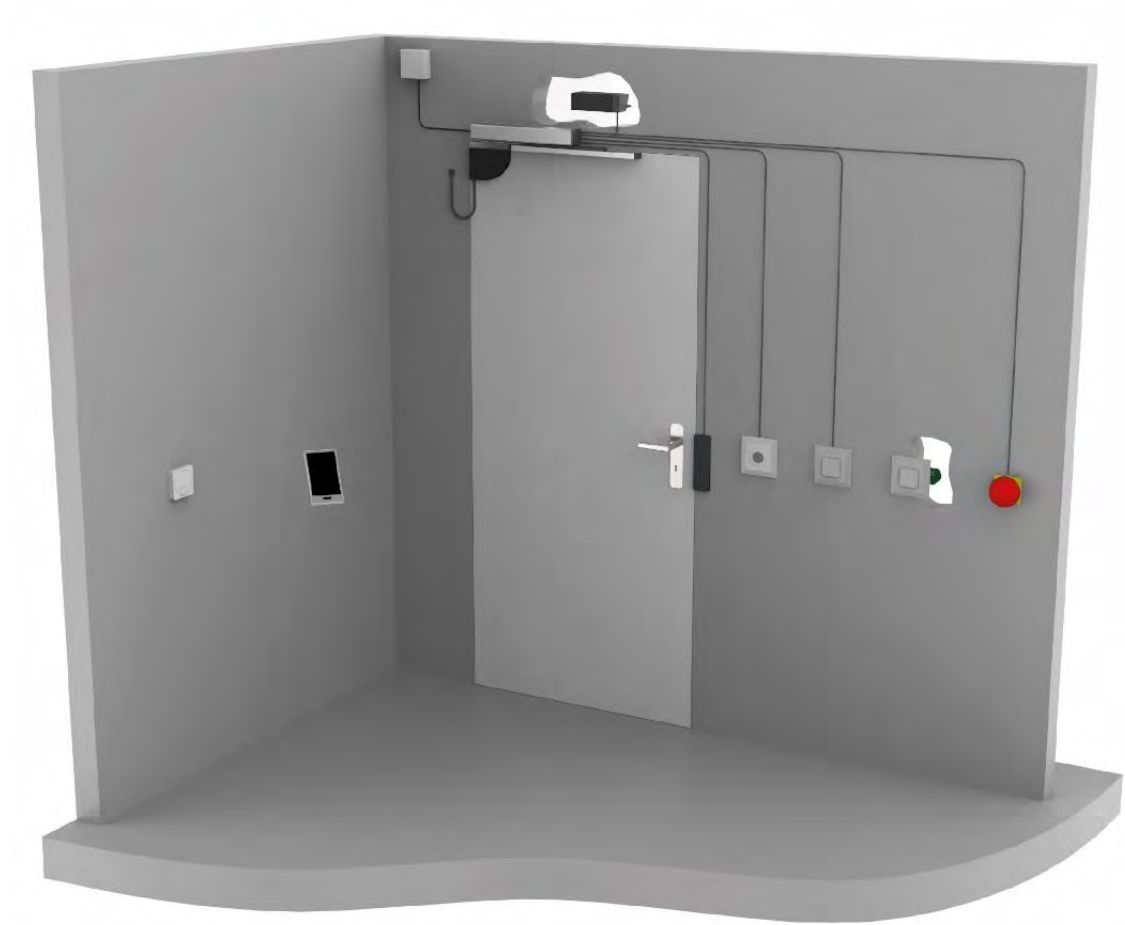

Figure 2: Product overview

1.2.1 The basic module

The new EN 16005 standard defines the LOW-ENERGY operating mode and allows a door operator to operate without safety elements without danger of injury. The smartdoor TURN targets precisely this application. With its Auto-Learning function it automatically calculates the necessary door parameters and makes easy work of commissioning. No safety elements are required.

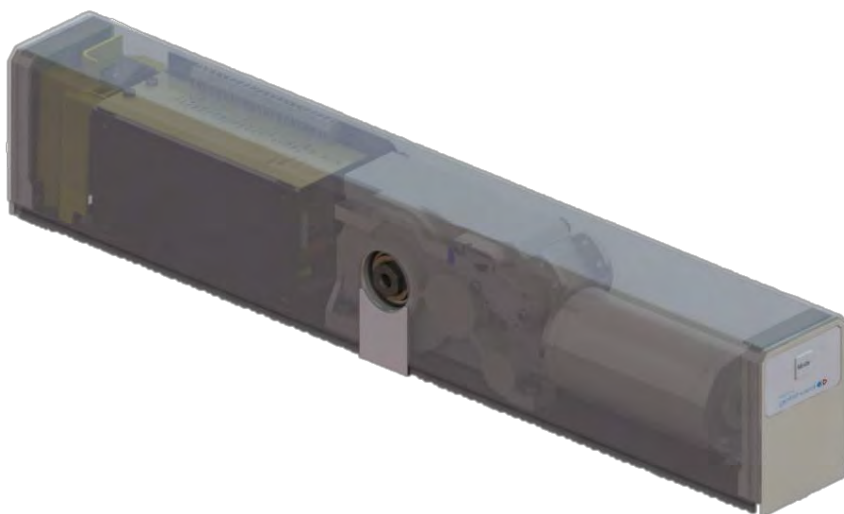

Figure 3: smartdoor TURN T100 basic module

1.2.2 The linkage

The smartdoor TURN can be fitted with the following linkage types:

- Sliding linkage
- Scissor linkage

The linkage types and their uses are described in chapter 3.3 Linkage types.

1.2.3 The operating elements

The smartdoor TURN can be fitted with the following elements:

- smartdoor Bluetooth button which opens the smartdoor TURN and can switch between the operating modes
- Standard switch, which opens the smartdoor TURN or can switch between the operating modes with the smartdoor Bluetooth module
- smartdoor APP which can open the smartdoor TURN, switch between the operating modes and change parameters
- Wired standard switch which can open the smartdoor TURN
- Wired radar which can open the smartdoor TURN

A separate function can be assigned to each button e.g. as opening contact (Day + Night), opening contact (Day), or mode switch



Figure 4: Operating element examples

If there is an additional switch for disabled persons to activate the drive, a pictogram needs to be applied to the button in accordance with EN 16005 Appendix D - picture D.1.

1.2.4 The safety elements

If you want to connect safety elements then the smartdoor TURN offers as standard a connection strip for all standard safety elements.

The smartdoor TURN can be fitted with the following safety elements:

- Presence sensors which control the swing range of the door in the opening direction (SIO)
- Presence sensors which control the swing range of the door in the closing direction (SIS)
- All standard motor locks and electric door openers (working current, static current)
- Key switches, rotary switches or timers, to switch between day and night mode



Figure 5: Examples of safety elements

1.2.5 The drive module

This 1.7 kg, extremely compact power pack can supply a drive-side torque of over 30 Nm and is practically silent. So that a driven door can also be actuated easily by hand (even without electricity), its internal efficiency on both sides has been corresponding optimised. The sensor system, integrated into the gearbox, allows a rapid and optimum reaction of the control system to external influences. (detection of obstacles, wind pressure etc.)

1.2.8 The smartdoor Service Tool

The smartdoor Service Tool can be used by the service technician on a Windows Notebook to carry out a wide range of adjustments after mechanical installation. This includes the following:

- Setting the parameters
- Activation of Bluetooth devices
- Saving and loading of parameter recipes
- Auto-Learning
- Managing and loading firmware
- Status overview for controlled commissioning of external equipment

The Service Tool is only for trained specialist personnel. A detailed description of the smartdoor Service Tool is provided in a separate handbook.

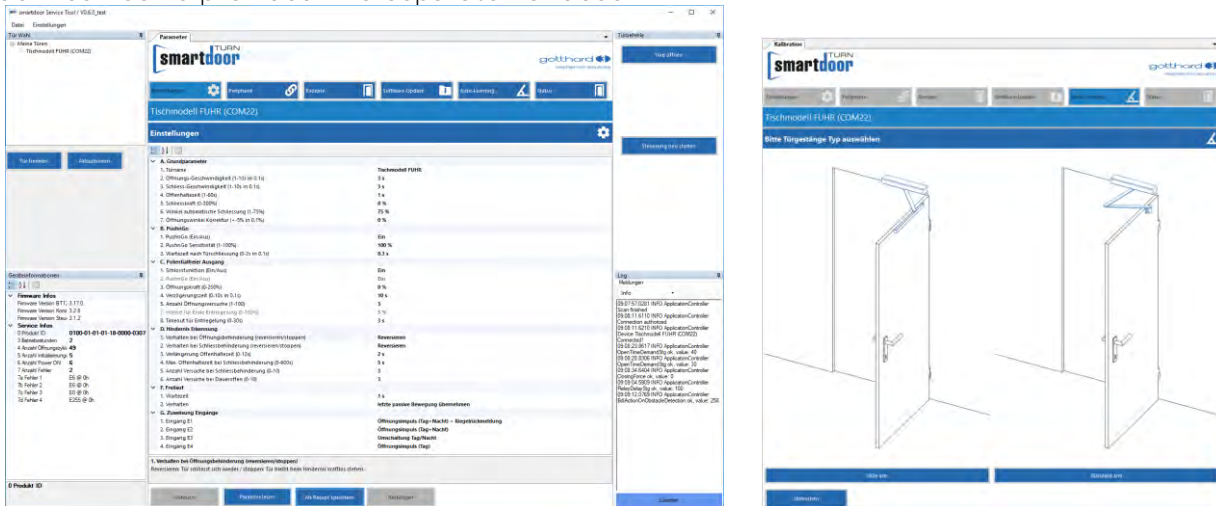

Figure 9: smartdoor Service Tool

1.2.9 The smartdoor APP

The smartdoor TURN can be operated and adjusted using the smartdoor APP.

A detailed description of the smartdoor APP can be found in chapter 7.5 smartdoor APP .



Figure 10: smartdoor APP

2 Safety

2.1 Symbols and display of warnings

Various symbols are used in these operating instructions for easier understanding:



NOTICE

Tips and information, which help you work correctly and efficiently.



CAUTION

Important note, when materials are damaged or the function can be affected.



WARNING

Important note, when materials are damaged or the function can be affected.

2.2 State-of-the-art and applied standards

The system complies with the state-of-the-art and accredited safety technology rules. It has been developed, constructed and produced in compliance with the following standards:

- Machinery Directive 2006/42/EC
- Household and similar electrical appliances. Safety. EN 60335-1
- Particular requirements for drives for gates, doors and windows EN 60335-2-103 (where applicable)
- Power operated pedestrian doorsets. Safety in use. Requirements and test methods. EN 16005.
- Doors, gates and windows - Product standard, performance characteristics - Fire and / or smoke protection properties EN 16034.
- Safety-related parts of control systems EN ISO 13849
13849-1:2016 (General design principles), category 2 PL c
13849-2:2016 (Validation)
- Electromagnetic compatibility (EMC) EN61000
Part 6-2: Generic standards – Immunity for industrial environments
Part 6-3: Generic standards – Emission standard for residential, commercial and light-industrial environments



NOTICE

Partly completed machinery in the sense of the EC directive 2006/42/EC is only designed to be installed in or combined with other machinery or in other partly

completed machinery or systems to form a machine in the sense of the above directive.



WARNING

This product may not be operated until it has been determined that the whole machine / system in which it has been installed, corresponds to the provisions of the above EC directive.

In the event of any alteration of the product without the manufacturer's approval, this declaration loses its validity.



NOTICE

The installer and operator must jointly carry out a risk assessment during the planning of the system.

Encoding systems for automatic doors (DIN 18650)

<ul style="list-style-type: none"> 1 – swing door operator 2 – Sliding door operator 3 – Swing/sliding door operator 4 – Folding door operator 5 – Revolving door drive 	Drive type	1
<ul style="list-style-type: none"> 1 – 200,000 test cycles at min. 1200 cycles/24 h 2 – 500,000 test cycles at min. 2400 cycles/24 h 3 – 1,000,000 test cycles at min. 4000 cycles/24 h 	Durability of the drive	2
<ul style="list-style-type: none"> 1 – Swing door 2 – Sliding door 3 – Swing/sliding door 4 – Folding door 5 – Revolving door 	Door leaf type	3
<ul style="list-style-type: none"> 0 – Not suitable as fire door 1 – Suitable as smoke-protection door 2* – Suitable as fire door 3 – Suitable as fire door & smoke-protection door 	Suitability as fire door	4
<ul style="list-style-type: none"> 1 – Force limit 2 – Connection for external safety systems 3 – Low energy 	Safety devices on the drive	5
<ul style="list-style-type: none"> 0 – No particular requirements 1 – In escape routes with a break-out fitting 2 – In escape routes without a break-out fitting 3 – For self-closing fire doors with break-out fitting 4 – For self-closing fire doors without a break-out fitting 	Special requirements of drive/functions and installation	6
<ul style="list-style-type: none"> 0 – No safety devices 1 – With adequately dimensioned safety distances 2 – With protection against crushing, shearing and trapping of fingers 3 – With built-in break-out fitting unit 4 – With presence sensor 	Safety on the automatic door system	7
<ul style="list-style-type: none"> 1 – No specifications 2 – from -15 °C to +50 °C 3 – from -15 °C to +75 °C 4 – Temperature range in accordance with the manufacturer's details 	Ambient temperatures	8

* Self-closing in combination with a battery

Table 1: Encoding systems for automatic doors

Nos. 1, 2, 5, 6, 8 relate to the drives.

Nos. 3, 4, 7 relate to the complete door systems

2.3 Intended use

The smartdoor TURN T100 is an electromechanical swing door operator and is designed exclusively for opening and closing swing doors for standard use in public and private dry interiors and standard door heights.

Any other use is considered as improper use. The manufacturer is not liable for damage resulting from improper use; the risk in this case lies entirely with the operator.

The smartdoor TURN T100 may be used on escape and rescue routes and on fire doors. Intended use of equipment also includes compliance with the manufacturer's operating instructions and regular care and maintenance.

2.4 Limitation of liability

Manipulation or modification of the parameters of the automatic door, unless performed by an authorised service technician, exempts the manufacturer from liability for any resulting damage. Modifications of the parameters may only be carried out by qualified personnel.

Installation is at one's own risk and must take place in accordance with operating instructions. The manufacturer accepts no responsibility for non-compliance.

Assembly, commissioning, inspection, maintenance and repair work on the system must be conducted according to the check lists. The chapter on commissioning (See chapter 5.3 Auto-Learning function) and the maintenance checklist (see inspection book) may be helpful here.

Children may not clean, play with or use the product.

2.5 User group

The swing door operator can be used by children from 8 years and above, elderly and frail users and persons with disabilities or with lack of experience and knowledge when these are supervised or have been instructed in relation to the safe use of the appliances and understand the resulting dangers.

Otherwise, the swing door operator should only be used when the risk assessment for the user indicates a low risk.

2.6 Risk

There are risks of shearing and crushing from the various closing edges and the linkage on automatic doors. To avoid this danger there should be no items in the opening area of the swing door. The securing of crushing and shearing points on secondary closing edges must be guaranteed by the door manufacturer.

The danger point on the secondary closing edge on each swing door (including manually operated) is generally recognised by all users of a door. It cannot be influenced by the manufacturer.

2.7 Misuse

Foreseeable misuse is any use other than as described in these operating instructions. This includes:

- mechanical or electrical bypassing
- The use of other than original parts
- Conversions, modifications and manipulations
- Non-compliance with the instructions



NOTICE

The manufacturer stated in this report is only the manufacturer of a drive and not the manufacturer of the final machinery.

The operator is responsible for the operation of automatic door systems and for regular maintenance and safety inspections.
The "Operator checks" checklist can be helpful for this (see inspection book).

3 Product description

3.1 Terms

Term	Explanation
Hinge side	The side of the door on which the hinges are located, to which the door leaf is attached. Usually, the side of the door facing the opening direction.
Opposite hinge side	The other side of the door to the hinge side. Usually, the side of the door facing the closing direction.
Contactor	Buttons, switches or motion detectors for actuation of the door operator. Actuation function in "automatic" operating mode and sometimes in other operating statuses.
Indoor opening contact (day + night)	Door opening button which is active in day and night mode and which is usually mounted on the inside of the door. The actuation function is activated in the "automatic" operating mode and opens the door automatically at the press of a button.
Outdoor opening contact (day only)	Door opening button which is only active when day mode is actuated and which is usually mounted on the outside of the door. The actuation function is activated in the "automatic" operating mode and opens the door automatically at the press of a button.
Push&Go	If the door is pushed manually out of the closed position in "automatic" operating mode, the door opens automatically. The sensitivity of this function can be set.
Safety sensor Opening (SIO)	Presence sensor (e.g., active infrared-light sensor or scanner) for securing the door swing range in the opening direction. The sensor is usually attached on the hinge side of the door to the door leaf and triggers a STOP pulse.
Safety sensor Closing (SIS)	Presence sensor (e.g. active infrared-light sensor or scanner) for securing the door swing range in the closing direction. The sensor is usually attached to the opposite hinge side of the door onto the door leaf and triggers a REOPEN pulse.
Emergency stop button (EMERGENCY)	Self-latching emergency stop button, which can stop the door operator immediately in an emergency. The EMERGENCY situation is ended by releasing the emergency stop button.
Electric door opener (LOCK)	Working and static current door opener (NC / NO) designed as AC or DC door opener. The delay time of the door opener is detected automatically by the control system.
Lock feedback (RR)	The lock feedback is an integrated contact in the door latch which is actuated by the mechanical locking of the door with the door lock bolt. It notifies the control system that the door is mechanically locked and cannot therefore be opened by the door operator.
Key switch (KEY)	Any standard commercial key switch can be used as a KEY. The key switch makes safe door opening possible from the interior and exterior. There are however many other functions available, e.g., day/night switch-over, which can be triggered with the key switch.
Airlock system (SLS)	Two consecutive doors, each with a door operator, which are connected together and ensure that only one door is open.

Closing sequence control (SFR)	System with two door leaves, each with a door operator. The two door leaves can be opened and closed in a mutually coordinated sequence.
--------------------------------	--

Table 2: Terms

3.2 Swing door terms

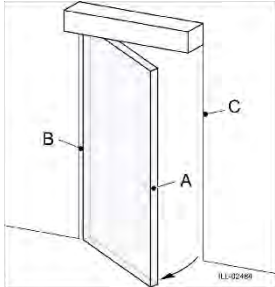





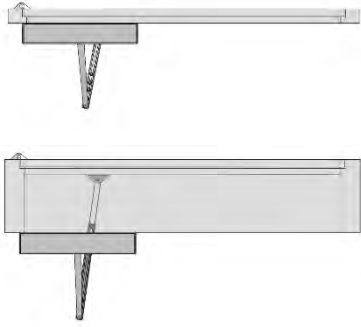

Figure 11: Swing door terms





Key:

- A Main closing edge
- B Secondary closing edge
- C Opposite closing edge

3.3 Linkage types

		Sliding linkage	Scissor linkage
Lintel assembly	Opposite hinge	3D: 	3D: 
		Front: 	Front: 
		Closed (lintel depth -20...+80 mm) 	Closed (lintel depth -20...+150 mm)  Lintel depth >150 mm with long insert profile

		Sliding linkage	Scissor linkage
		<p>Open (lintel depth -20... +80 mm):</p> <p>Opening angle max. 100°</p>	<p>Open (lintel depth -20... +150 mm):</p> <p>Opening angle max. 110°</p> <p>Opening angle max. 110°</p>
Lintel assembly	Hinge side	<p>3D:</p>	<p>3D: Assembly not possible</p>
		<p>Front:</p>	
		<p>Closed (overfold -80... +80 mm)</p>	

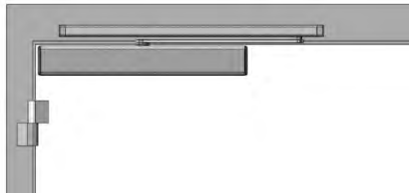
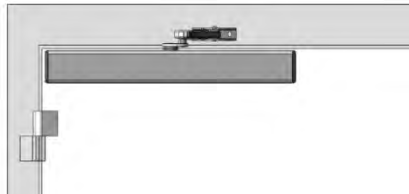
		Sliding linkage	Scissor linkage
		<p>Open (overfold -80...+80 mm)</p>  <p>Opening angle max. 110°</p>	
Door leaf assembly	Opposite hinge	<p>3D: Assembly not recommended</p>  <p>Opening angle max. 80°</p>	<p>3D: Assembly not possible</p>
Door leaf assembly	Hinge side	<p>3D:</p> 	<p>3D:</p> 
		<p>Front:</p> 	<p>Front:</p> 

	Sliding linkage	Scissor linkage
	<p>Closed (overfold 0...+60 mm)</p>	<p>Closed (overfold -20...+100 mm)</p> <p>Overfold >100 mm with long insert profile</p>
	<p>Open (overfold 0...+60 mm)</p> <p>Opening angle max. 100°</p>	<p>Open (overfold -20...+100 mm)</p> <p>Opening angle max. 100° From overfold >50 mm: 90°</p>

Table 3: Linkage types (DIN left)

3.4 Holding variants

There are generally three holding variants:

- 1 Door handle with latch (with and without lock)
- 2 Door handle with blocked latch (with and without lock)
- 3 Door handle with latch and electric door opener

3.4.1 Door handle with latch (with and without lock)

Holding variants:

This is a normal door with a door handle and possibly a lock.

Open:

The door handle must be actuated by a person to open the door. Remote actuation is not possible. After actuating the door handle, a Push&Go is detected inside and outside and the door opens.

Close:

When closing, the door operator checks that the door closes fully and the latch engages.

Locking:

The door is mechanically locked and cannot now be opened.

If remote actuation is required, the latch clip can be used (see chapter 3.4.2 Door handle with blocked latch (with and without lock) or an electric door opener mounted (see chapter 3.4.3 Door handle with latch and electric door opener).

3.4.2 Door handle with blocked latch (with and without lock)

Holding variants:

In this variant the latch is mechanically disabled with the latch clip and the door is held with the patented closing function.

Open:

All opening pulses (wired and via Bluetooth) and Push&Go are possible.

Close:

When closing, the door operator checks that the door closes fully. The holding force is applied by the patented closing function and can be adjusted with the Auto-Learning function (see chapter 5.3 Auto-Learning function).

Locking:

The door is locked mechanically. The door operator recognises this after three unsuccessful opening attempts.

3.4.3 Door handle with latch and electric door opener

Holding variants:

In this variant the electric door opener holds the door in the closed position.

Open:

All opening pulses (wired and via Bluetooth) and Push&Go are possible.

Close:

When closing, the door opener checks that the door closes fully, the latch engages and is locked with the electric door opener.

If the electric door opener does not lock, (a variable number) attempts are made to lock the door correctly. The door then remains unlocked in the closed position.

Locking:

The electric door opener locks the door mechanically.

The door operator recognises a locked door after three unsuccessful opening attempts. And switches off all trip-commands and safety elements until the door has moved again for the first time.

4 Assembly

These operating instructions, together with the drilling template, act as assembly instructions. These documents can also be found in the smartdoor APP:

- Mechanical assembly
- Electrical connections
- Wired signal connections
- Forces and torques setting for the hold-shut torque
- Set-up and configuration mode (Auto-Learning function)



WARNING

IMPORTANT INSTRUCTIONS FOR SAFE ASSEMBLY:

Follow all instructions with care, incorrect assembly can lead to serious injury

4.1 Safety during assembly:

- The installer must check that the ambient temperature range stated on the drive is appropriate for the installation location.
- Before the installation of the smartdoor TURN T100, check that it is in a mechanically sound state and is running smoothly.
- The maximum installation height is 2.5 m.
- It must be ensured that entrapment between the driven part and the surrounding fixed parts is prevented when the driven part opens. This is achieved by ensuring that the corresponding gap does not exceed 8 mm. Nevertheless, the following clearances are adequate to prevent trapping of body parts:
 - for fingers - the gap must be greater than 25 mm;
 - for feet - the gap must be greater than 50 mm;
 - for the head - the gap must be greater than 200 mm; and
 - for the whole body, the gap must be greater than 500 mm.

4.2 Mechanical installation

The mechanical installation is carried out using the drilling template (see Figure 12: Drilling template, example lintel assembly, opposite hinge DIN Right). Place the drilling template vertically to the edge of the door leaf and horizontally to the edge of the door lintel. This shows the positions of the holes for the mounting plate or adapter plate, the sliding rail and the scissor linkage.

In this case it makes no difference whether the mounting plate is assembled as shown in the drilling template or is rotated by 180°. If rotating the mounting plate, the user needs to mark the drilling holes.

The chosen gap of the door operator with respect to the position of the sliding rail or the bottom of the scissor linkage gives the length of the axle extension: Red area = 7 mm; Blue area = 15 mm; Green area = 30 mm.

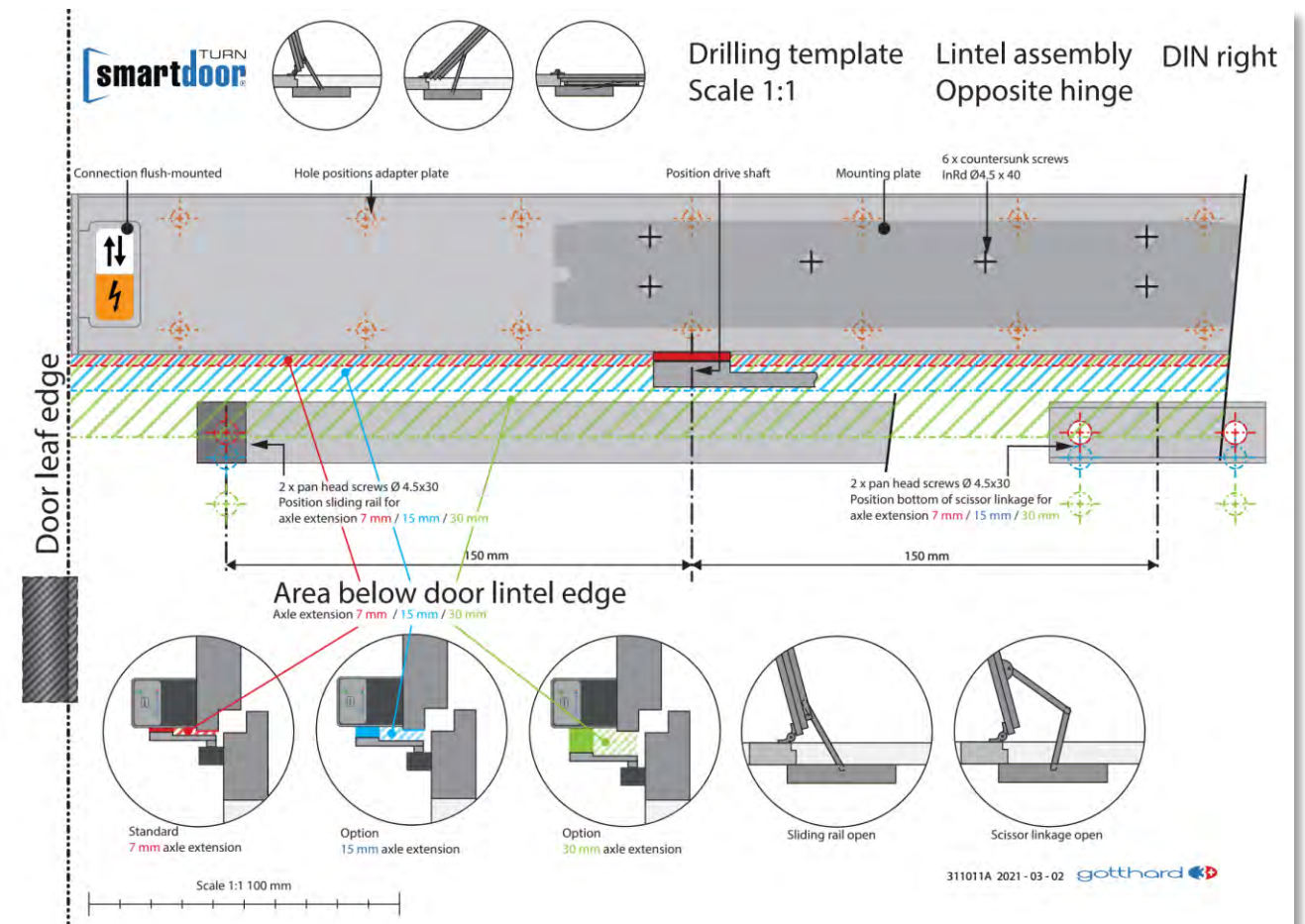

Figure 12: Drilling template, example lintel assembly, opposite hinge DIN right

4.2.1 Mounting plate

The holes of the mounting plate are the same as a mounting plate of a standard door closer. Therefore a mechanical door closer can be replaced with minimum outlay with the smartdoor TURN.

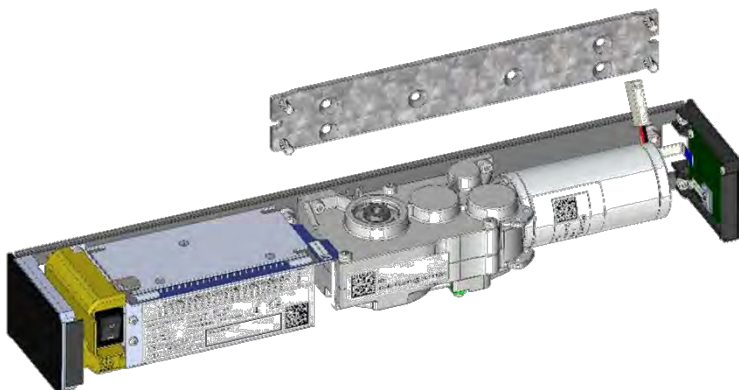

Figure 13: Mounting plate



NOTICE

Rotating the mounting plate by 180° can increase the gap from the door operator to the door edge by 8 mm.



NOTICE

The screws provided are for attaching to wood or stone. Special screws are used for attachment to metal (not in scope of delivery).



WARNING

The mounting plate must always be attached with all 6 screws. In this case the screws supplied or equivalent-quality screws, in which the screw head is recessed completely, are used.

4.2.2 Adapter plate

In difficult installation situations, the adapter plate can be used.



Figure 14 Adapter plate



NOTICE

Drill more holes as required. Make sure that no screw head protrudes.



WARNING

The adapter plate must be attached with at least $5+2=7$ screws. Primary fastening: in a line with at least 5 screws, two of which in the outermost holes. Support: in the second line with at least 2 screws. Example:



Figure 15 Adapter plate with assembly example



WARNING

In this case the screws supplied or equivalent-quality screws, in which the screw head is recessed completely, are used.

4.2.3 Assembly linkage

The linkage is connected with the axle extension to the door operator the axle extension is attached to the door operator using an M6 screw and a lock washer on the linkage side. The maximum allowable torque for tightening is 10 Nm.

Axle extensions are supplied in different lengths so that the gap between the door operator and the sliding rail or the linkage foot can be adapted to the respective circumstances.



NOTICE

The axle extension is attached to the door operator without play with a press fitting. The axle extension is inserted with an Allen key and the screw provided.



WARNING

Do not hammer the axle extension into the press fitting as this will damage the transmission.

4.2.4 Linkage disassembly

If you need to remove the linkage, remove the M6 screw first. This will give access to the M8 internal thread of the axle extension. With the M8 screw supplied, the axle extension can be knocked out of the press fitting.



NOTICE

Disassembly of the linkage takes place with the M8 screw provided.

4.3 Electric installation

Loosening and removing the yellow protective cap gives access to the screw terminals and the earth conductor for the supply voltage.

To remove the protective cap, insert a screwdriver into the recess marked with an arrow and push back the catch (step 1). You can then pull the protective cap up and off (step 2) by hand.

Notice: Removing the side panel can ease the process considerably.

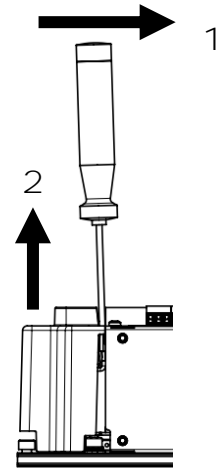

WARNING

Removal of the protective cap means that live parts are accessible. Touching these parts can be a danger to life.

4.3.1 Connection AC version

For connection it must be ensured that the drive depends on a separate circuit with max. 16 A fuse protection.

Both power-carrying conductors must be attached to the correspondingly labelled screw terminals.

Phase conductor → L

Neutral conductor → N

The mains-side earth conductor is attached to the earth conductor of a Wago socket terminal.

Cable manufacture

Cross section: min. 1.5 mm² to max. 2.0 mm²

Type: wire or stranded wire*

Voltage: 100-240 VAC

*A stranded wire must be provided with an appropriate, approved sleeve

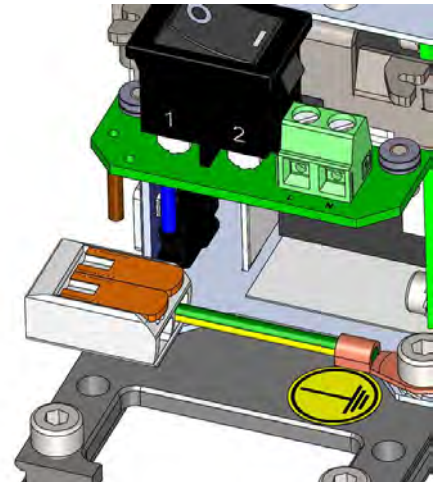

4.3.2 Connection DC version

For connection it must be ensured that the drive is connected to a certified, external power supply designed for this door drive with a separate circuit with max. 16 A fuse protection.

Both power-carrying conductors must be attached to the correspondingly labelled screw terminals.

+24 VDC → +

GND → -

The mains-side earth conductor is attached to the earth conductor of a Wago socket terminal.

Cable manufacture

Cross section: min. 1.5 mm² to max. 2.0 mm²

Type: wire or stranded wire*

Voltage: 22-28 VDC

*A stranded wire must be provided with an appropriate, approved sleeve

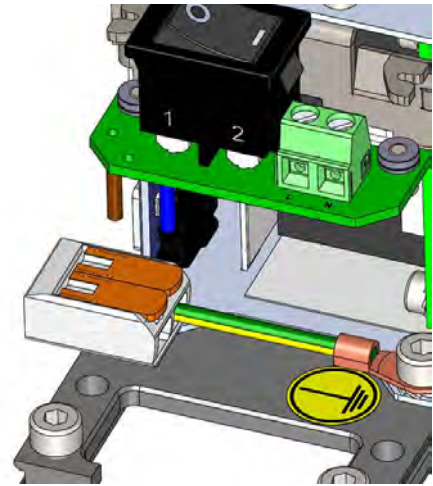

4.4 Commissioning via Auto-Learning function

The commissioning of the drive is carried out with the help of the Auto-Learning function. The drive learns the door's physical characteristics and adjusts the values for the LOW-ENERGY mode. In addition, the most important parameters are automatically recognised and the holding force is set.

The Auto-Learning function is described in chapter 5.3 Auto-Learning function.

4.4.1 Functional test (commissioning Push&Go)

After Auto-Learning, the drive is ready for operation in "automatic" mode. If the door is contacted, the door operator recognises this as the Push&Go command, the door opens to the programmed open-position and closes the door after the preset hold-open time.



NOTICE

The simplest functional test can be initiated by triggering a Push&Go opening command.

4.4.2 Functional test (after installation)

The functional test must be carried out after completed installation according to the checklist "Operator checks" (see inspection book).

4.4.3 Holding force functional test in the case of current interruption

The holding force comes into play in the case of current interruption and closed door. When the door opens, this holding force disappears from an angle of approx. 15° and guarantees easy opening of the door. If the door is closed manually, this holding force starts from an angle of approx. 15°, the door closes automatically in this last range and is held in the closed state. This function must be tested.

4.4.4 Function test (start after current interruption)

The behaviour of the drive after a current interruption is described in chapter 5.1 Automatic switch-on function after power failure and must be tested.

4.5 Commissioning operating elements

Further operating elements can now be assigned to the drive. The smartdoor TURN can be fitted with the following elements:

- smartdoor Bluetooth button which opens the smartdoor TURN and can switch between the operating modes
- Standard switch, which opens the smartdoor TURN or can switch between the operating modes with the smartdoor Bluetooth module
- smartdoor APP which can open the smartdoor TURN, switch between the operating modes and change parameters
- Standard wired push button, key switch or rotary switch, which opens the smartdoor TURN or can switch between the operating modes
- Standard wired trip-sensor (Radar, IR, etc.), which can open the smartdoor TURN

The Service Tool can be used to define the function which is designed to actuate an operating element. There are various standard functions available for this. If you are interested in special functions or customer-specific functions, please feel free to contact us

4.5.1 Bluetooth operating elements

Bluetooth operating elements are connected via Bluetooth to the drive and can be configured with the smartdoor Service Tool. The available functions are listed Table 14: Assignment of function to inputs and outputs.

4.5.1.1 Addition of Bluetooth operating elements

To add a Bluetooth operating element to the door operator, the communication module must be switched to pairing mode. To do this, press and release the BLUETOOTH push button on the communication module. The LED starts to flash blue for confirmation.



Figure 16: BLUETOOTH push button

The communication module remains in scanning mode for approx. 15 seconds and searches for Bluetooth devices. The first smartdoor Bluetooth operating element to transmit a switching command in this period is added to the drive as a new operating element.

A beep is sounded when a new operating element is added successfully to the drive and appears in the "White List".



NOTICE

The operating element is NOT activated after addition.
The Service Tool is used for activation and for allocation of a function.

4.5.1.2 Deleting Bluetooth operating elements

Press the BLUETOOTH button (see Figure 16: BLUETOOTH push button) for at least 5 seconds and wait for the sequence of beeps to delete all added operating elements on the communication module. The drive can no longer be operated with a Bluetooth operating element. The operating elements must be re-added individually (see chapter 4.5.1.1 Addition of Bluetooth operating elements)



NOTICE

If a notebook or smartphone which was connected with the door operator has been deleted from the White List, you also need to remove its Bluetooth Pairing before you can reconnect it.

4.5.1.3 Commissioning of smartdoor Bluetooth push button



Figure 17: smartdoor Bluetooth push button

The addition of the smartdoor Bluetooth push button to the door operator is described in chapter 4.5.1.1 Addition of Bluetooth operating elements



NOTICE

The Bluetooth push button is NOT activated after the addition.
The Service Tool is used for activation and for allocation of a function.

Test:

When actuating the Bluetooth push button a signal is sent to the door operator. In this case the LED in the communication module lights up briefly if the switch command has been recognised.

4.5.1.4 Commissioning of smartdoor Bluetooth module (with push button)

The Bluetooth module can be connected to any standard push button or floating contact. This allows free choice of the push button or connection to external systems such as KNX.

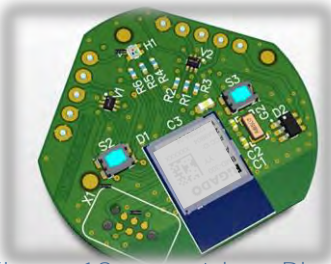

Figure 18: smartdoor Bluetooth module

Connecting the smartdoor Bluetooth module to the push button:



- : GND
- T1: Function 2 (yellow)
- T2: Function 1 (green)
- Rs: Reset
- B+: 3.3 VDC (red)

Figure 19: smartdoor Bluetooth module connections

External push button with function 1:

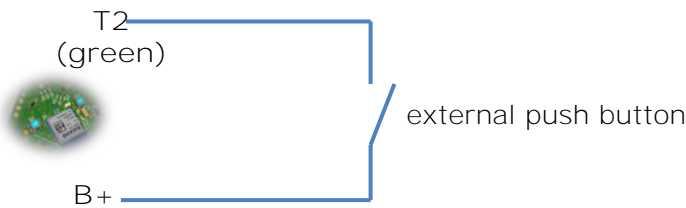

External push button with function 2:

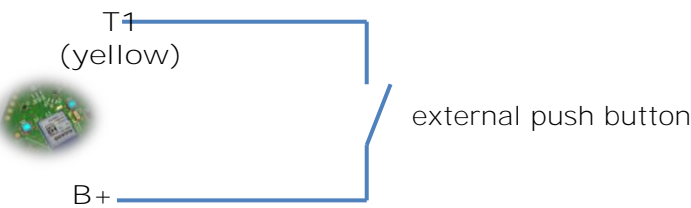

The addition of the smartdoor Bluetooth push button to the door operator is described in chapter 4.5.1.1 Addition of Bluetooth operating elements.



NOTICE

The Bluetooth module is NOT activated after the addition.
The Service Tool is used for activation and for allocation of a function.

Test:

When the Bluetooth module is activated, a signal is transmitted to the door operator. In this case the LED in the communication module lights up briefly if the switch command has been recognised.

4.5.1.5 Addition of smartphone

The addition of a smartphone to the "White List" of the door operator is described in chapter 7.5.3 Connect new door operator in the APP.

4.5.2 Wired operating elements

Wired operating elements are connected to the drive via the floating inputs E1, E2, E3 and E4 of the connecting terminal and can be configured with the smartdoor Service Tool. The available functions are listed in Table 14: Assignment of function to inputs and outputs.

The smartdoor TURN offers as standard four independent power supplies for external accessories with a voltage of 24 VDC and a maximum current load of 800 mA.

4.5.2.1 Connection of external contacts

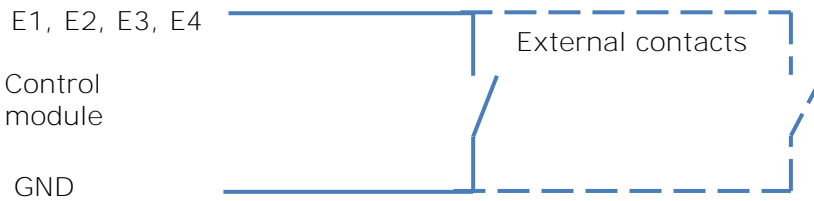

Figure 20: Connection diagram for external contacts

4.5.2.2 Wired opening pulses

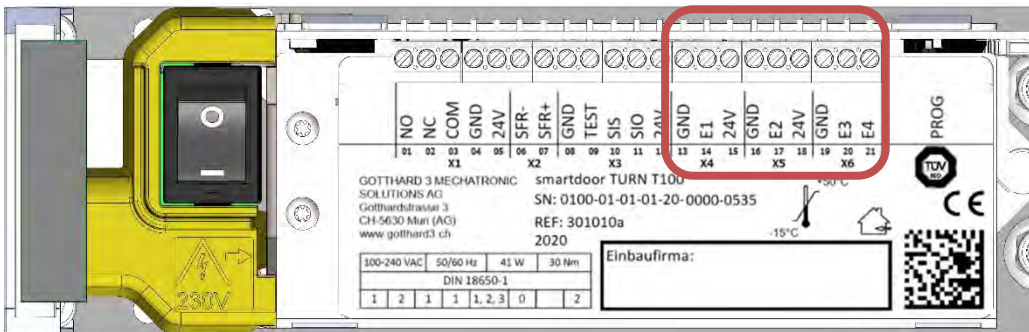

Figure 21: Connecting terminals for wired opening pulses

X4.13	GND		GND ¹⁾
X4.14	E1	Function is set via Service Tool. Default: Opening pulse (Day+Night)	Input 1: Floating contact
X4.15	24 V		VDC 3: Short-circuit-proof
X5.16	GND		GND ¹⁾
X5.17	E2	Function is set via Service Tool. Default: Opening pulse (Day+Night)	Input 2: Floating contact
X5.18	24 V		VDC 4: Short-circuit-proof
X6.19	GND		GND ¹⁾
X6.20	E3	Function is set via Service Tool. Default: Day/Night switch-over	Input 3: Floating contact
X6.21	E4	Function is set via Service Tool. Default: Opening pulse (Day)	Input 4: Floating contact

Table 4: Connecting terminals for wired opening pulses

4.5.2.3 Commissioning wired push button

All standard commercial push buttons with a floating contact can be used.

1 The cover is removed and the door operator is switched off

- 2 The contact from the push button is connected to GND with a two-core cable and to one of the connecting terminals E1, E2, E3 or E4
- 3 The drive is switched on and the cover replaced
- 4 The Service Tool is used to assign the input to the "Opening pulse (Day/Night)" or the "Opening pulse (Day)" function (see chapter 5.5 Functions of inputs and outputs)

4.5.2.4 Commissioning wired radar

All standard commercial radars with a floating contact can be used.

- 1 The cover is removed and the door operator is switched off
- 2 The floating contact from the radar is connected to GND with a two-core cable and to one of the connecting terminals E1, E2, E3 or E4
- 3 A radar with a 24 VDC feed can tap its power supply from the terminals X4.15 / X5.18 (24 V) and X4.13 / X5.16 / X6.19 (GND)
- 4 The drive is switched on and the cover replaced
- 5 The Service Tool is used to assign the input to the "Opening pulse (Day/Night)" or the "Opening pulse (Day)" function (see chapter 5.5 Functions of inputs and outputs)

4.6 Commissioning safety elements

All standard commercial safety elements can be used, in other words:

- Presence sensors which control the swing range of the door in the opening direction (SIO)
- Presence sensors which control the swing range of the door in the closing direction (SIS)
- All standard electric door openers (working current, static current) and motor locks
- Key switch, to switch between day and night mode

4.6.1 Commissioning SIO and SIS presence sensors

All standard commercial presence sensors can be used as SIO (sensor for safety when opening) and SIS (sensor for safety when closing). Corresponding electrical diagrams can be found on the Homepage in the download area.

4.6.1.1 Connection SIO / SIS

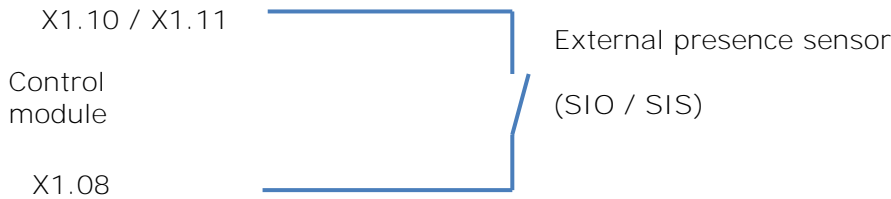

Figure 22: External presence sensor connection diagram

4.6.1.2 Test signal TEST

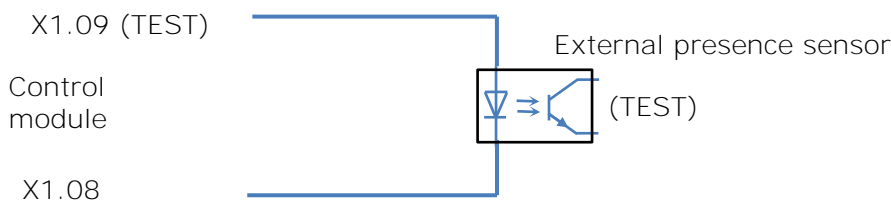

Figure 23: Connection diagram from the test signal of an external presence sensor

- 1 The cover is removed and the door operator is switched off
- 2 The presence sensor is connected with a two-core cable to the SIS and TST or SIO and TST connecting terminals on the control board itself
- 3 With a further two-core cable, the presence sensor with 24 VDC feed can tap its power supply from the terminals X3.08 (GND) and X3.12 (+24 VDC)
- 4 The drive is switched on and the cover replaced
- 5 After switching on the door operator, stop signals from a presence sensor are detected by the system (drive continues to run in LOW-ENERGY mode)
- 6 After initial assembly the presence sensor must undergo learning and testing once with Auto-Learning or the Service Tool to guarantee correct functioning. The process is described in the operating manual of the Service Tool.

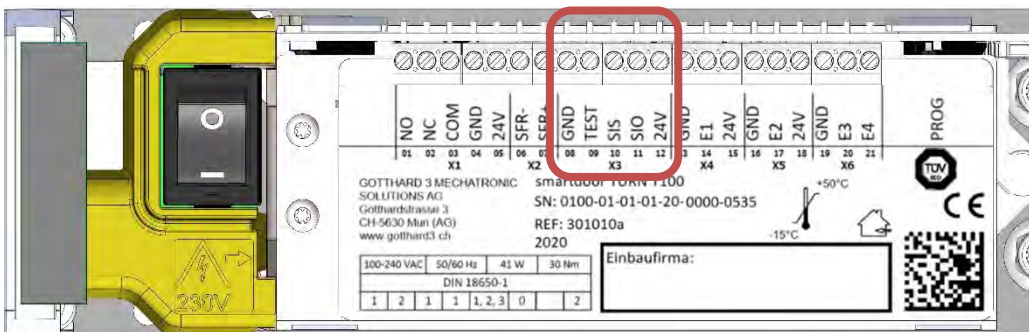

Figure 24: Connecting terminals for SIO and SIS presence sensors

X3.08	GND	Safety elements	GND ¹⁾
X3.09	TEST		Output: Test signal +24 VDC
X3.10	SIS		Input: Safety when closing
X3.11	SIO		Input: Safety when opening
X3.12	24 V		VDC 2: Not short-circuit-proof

Table 5: Connecting terminals for SIO and SIS presence sensors

4.6.2 Commissioning electric door opener (COM, NO and NC)

All standard commercial electric door openers (working current, static current) can be used. Corresponding electrical diagrams can be found on the Homepage in the download area.

- 1 The cover is removed and the door operator is switched off
- 2 The electric door opener is connected with a two-core cable to GND and to the corresponding connecting terminal NO or NC of the door operator
 Electric door opener with working current principle connected to NO
 Electric door opener with static current principle connected to NC
- 3 The feed voltage for the electric door opener is connected to the connecting terminal COM. If its feed voltage is 24 VDC, an electrical bridge between X1.05 (24 V) and X1.03 (COM) enables the use of the voltage from the door operator.
- 4 The drive is switched on and the cover replaced
- 5 The delay time and further settings can be adapted with the Service Tool.

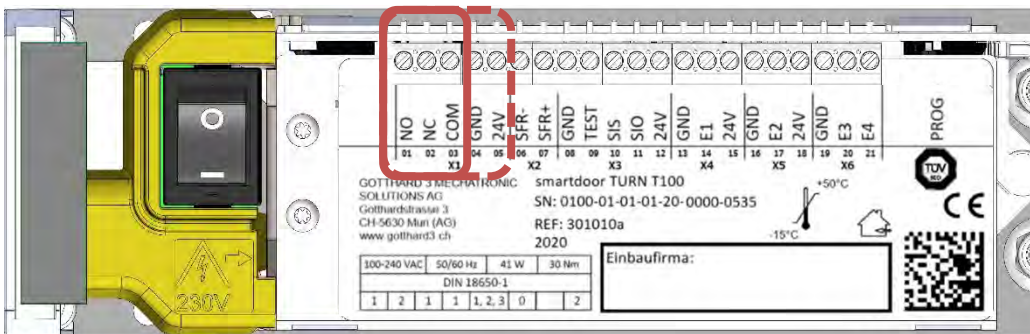

Figure 25: Connecting terminals for electric door opener

X1.01	NO	Programmable relay	Output: NO (working current principle)
X1.02	NC		Output: NC (static current principle)
X1.03	COM		Input: COM with 0-125 VAC/DC, 1 A
X1.04	GND		GND ¹⁾
X1.05	24 V		VDC 1: Short-circuit-proof

Table 6: Connecting terminals for electric door opener

4.6.3 Commissioning motor lock (COM, NO and NC and more)

All standard commercial motor locks can be used. Electrical diagrams are provided for the most common motor locks. As well as wiring, these contain the parameters of the motor lock and door operator.

In this case our ideal is that the original wire from the motor lock is connected directly to the door operator, as far as possible without a junction box or terminal strip.

Corresponding electrical diagrams can be found on the Homepage in the download area.

- 1 The cover is removed and the door operator is switched off
- 2 The parameters of the motor lock are set according to the electrical diagram
- 3 The motor lock is connected according to the electrical diagram to the door operator
- 4 The drive is switched on and the cover replaced
- 5 The parameters of the door operator and more settings are adjusted with the Service Tool.

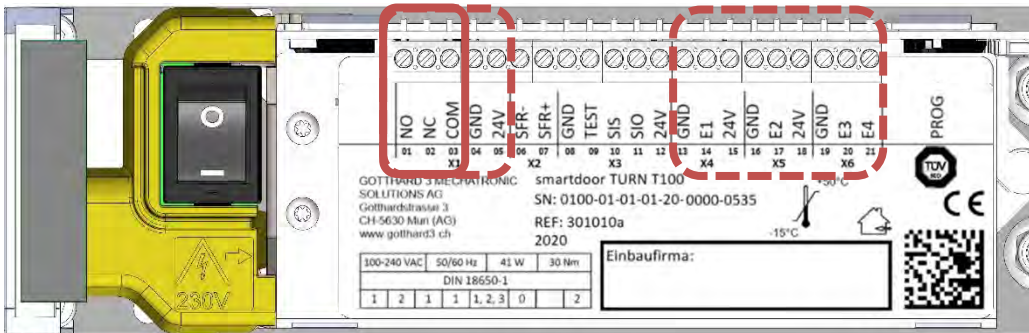

Figure 26: Connecting terminals for motor lock

X1.01	NO	Programmable relay	Output: NO (working current principle)
X1.02	NC		Output: NC (static current principle)
X1.03	COM		Input: COM with 0-125 VAC/DC, 1 A
X1.04	GND		GND ¹⁾
X1.05	24 V		VDC 1: Short-circuit-proof

X4.13	GND	Function is set via Service Tool. Default: Opening pulse (Day+Night)	GND ¹⁾
X4.14	E1		Input 1: Floating contact
X4.15	24 V		VDC 3: Short-circuit-proof
X5.16	GND	Function is set via Service Tool. Default: Opening pulse (Day+Night)	GND ¹⁾
X5.17	E2		Input 2: Floating contact
X5.18	24 V		VDC 4: Short-circuit-proof
X6.19	GND	Function is set via Service Tool. Default: Day/Night switch-over	GND ¹⁾
X6.20	E3		Input 3: Floating contact
X6.21	E4		Input 4: Floating contact

Table 7: Connecting terminals for motor lock

4.6.4 Commissioning Day/Night switch-over

All standard commercial key switches, rotary switches or timers can be used for Day/Night switch-over.

Corresponding electrical diagrams can be found on the Homepage in the download area.

- 1 The cover is removed and the door operator is switched off
- 2 The key switch is connected with a two-core cable e.g., to the connecting terminals E3 and GND directly to the control board
- 3 The drive is switched on and the cover replaced
- 4 The Service Tool is used to assign the function "Day/Night switch-over" to the input (in this case E3)

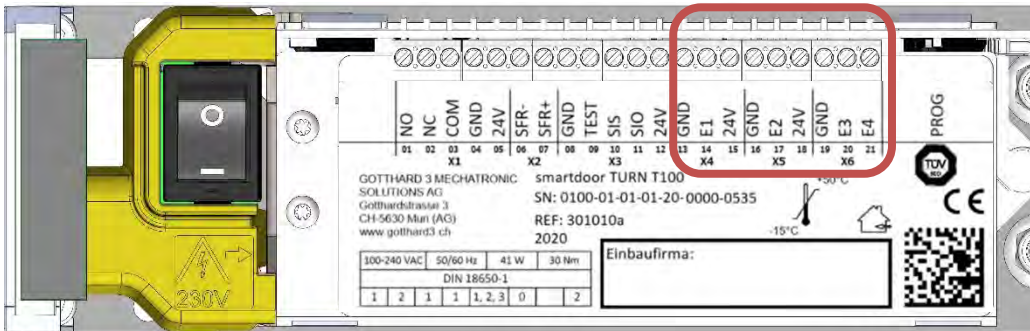

Figure 27: Connecting terminals for Day/Night switch-over

X4.13	GND	Function is set via Service Tool. Default: Opening pulse (Day+Night)	GND ¹⁾
X4.14	E1		Input 1: Floating contact
X4.15	24 V		VDC 3: Short-circuit-proof
X5.16	GND	Function is set via Service Tool. Default: Opening pulse (Day+Night)	GND ¹⁾
X5.17	E2		Input 2: Floating contact
X5.18	24 V		VDC 4: Short-circuit-proof
X6.19	GND		GND ¹⁾
X6.20	E3	Function is set via Service Tool. Default: Day/Night switch-over	Input 3: Floating contact
X6.21	E4	Function is set via Service Tool. Default: Opening pulse (Day)	Input 4: Floating contact

Table 8: Connecting terminals for Day/Night switch-over

4.6.5 Commissioning closing sequence control (wired)

The closing sequence control is used for a door with two door leaves, each equipped with a door opener. The two door leaves can be opened and closed in controlled relation to each other. For this purpose, the door positions at which a mutual interlocking is activated or cancelled can be defined.

The drive on the traffic leaf acts as a master and is responsible for unlocking the lock, can accept all available opening signals and supports the common presence sensors.

The drive on the stationary leaf acts as a slave, can accept all available opening signals, forwards them to the master and supports the usual presence sensors.

The corresponding electrical diagram including the default parameters can be found on the homepage in the download area.

Principle scheme

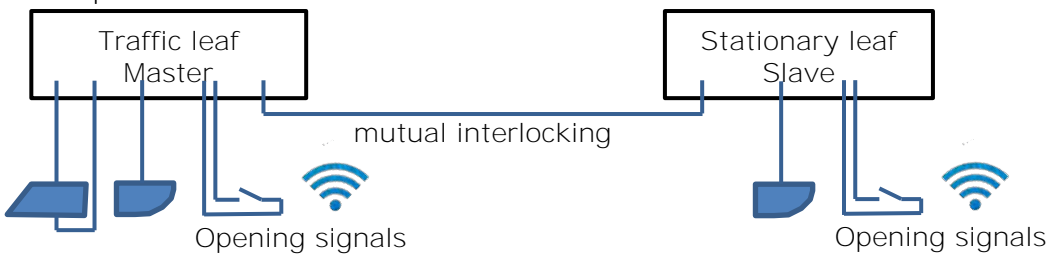

Figure 28: Principle-scheme closing sequence control

- 1 Remove the cover from both drives and switch off both drives.
- 2 The connecting cable between the master and slave drive is laid and connected to both drives according to the electrical diagram (master and slave signals).
- 3 Connect the lock to the master drive according to the electrical diagram.
- 4 The push buttons for the opening signals are connected to the master or slave drive.
- 5 Optionally, a presence detector is connected to the master and slave drive (see Service Tool operating instructions).
 IMPORTANT: The correct parameters of the sensor must be set according to the electrical diagram.
 INFO: Drive continues to run in LOW-ENERGY mode
- 6 The two drives are switched on and the covers are replaced.
- 7 Use the Service Tool to set the parameters for the lock in use.
- 8 Use the Service Tool to set the parameters for the inputs according to the application.
- 9 Use the Service Tool to set the parameters for the lock sequence control. The positions of the mutual interlocking, the hold-open times and the settings of the unlocking must be adapted to the application and tested.



NOTICE

The default parameters on the electrical diagram only serve as an example. The positions of the mutual interlocking, the hold-open times and the settings of the unlocking must be adapted to the application and tested.



WARNING

Incorrectly set parameters for the positions of the mutual interlocking, the hold-open times and the settings of the unlocking can lead to mechanical defects on the door and door operator.

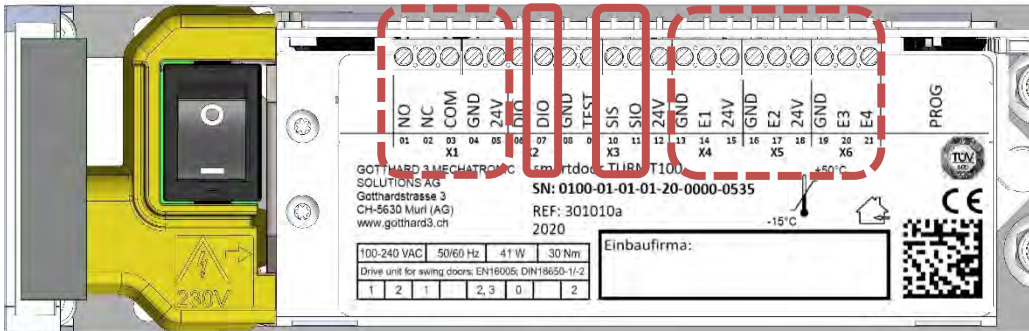

Figure 29: Connecting terminals for closing sequence control

X1.01	NO	Programmable relay	Output: NO
X1.02	NC		Output: NC
X1.03	COM		Input: COM with 0-125 VAC/DC, 1 A
X1.04	GND		GND ¹⁾
X1.05	24 V		VDC 1: Short-circuit-proof
X2.06	(DIO)	Freely programmable in / output	Inverted signal of DIO
X2.07	DIO		Digital I/O
X3.08	GND	Safety elements	GND ¹⁾
X3.09	TEST		Output: Test signal +24 VDC
X3.10	SIS		Input: Safety when closing
X3.11	SIO		Input: Safety when opening
X3.12	24 V		VDC 2: Not short-circuit-proof
X4.13	GND	Function is set via Service Tool. Default: Opening pulse (Day+Night)	GND ¹⁾
X4.14	E1		Input 1: Floating contact
X4.15	24 V		VDC 3: Short-circuit-proof
X5.16	GND	Function is set via Service Tool. Default: Opening pulse (Day+Night)	GND ¹⁾
X5.17	E2		Input 2: Floating contact
X5.18	24 V		VDC 4: Short-circuit-proof
X6.19	GND		GND ¹⁾
X6.20	E3	Function is set via Service Tool. Default: Day/Night switch-over	Input 3: Floating contact
X6.21	E4	Function is set via Service Tool. Default: Opening pulse (Day)	Input 4: Floating contact

Table 9: Connecting terminals for closing sequence control

4.6.5.1 Locking the stationary leaf:

The traffic leaf has the option of interlocking the stationary leaf to ensure that the stationary leaf can no longer open. Closing of the stationary leaf is still possible.

The interlocking of the stationary leaf can be set separately depending on the position of the traffic leaf during opening and closing and sets the signal SIO (protection during opening). In the electrical diagram, the locking range of the stationary leaf is marked as "OPEN" for the traffic leaf.



HINWEIS

When the stationary leaf is locked, it is possible to move the stationary leaf by hand at any time. When opening the locked stationary leaf by hand, increased forces may be required.

4.6.5.2 Interlocking the traffic leaf:

The stationary leaf has the option of interlocking the traffic leaf to ensure that the traffic leaf can no longer close. It is still possible to open the traffic leaf.

The interlocking of the traffic leaf can be set separately depending on the position of the stationary leaf during opening and closing and sets the SIS signal (protection during closing). In the electrical diagram, the range of the traffic leaf interlocking on the stationary leaf is marked as the "OPEN" range.



NOTICE

When the traffic leaf is locked, it is possible to move the traffic leaf manually at any time. When closing the interlocked active leaf by hand, increased forces may be required.



NOTICE

The door operator has an electrical but no mechanical interlocking of the active leaf. Local legislation determines whether the traffic leaf must be mechanically interlocked with the stationary leaf. If this is the case, it must be implemented with a separately provided device.

4.6.5.3 Opening the traffic leaf only:

If it is required that the traffic leaf can be opened separately, there are two options for this:

- 1 A Bluetooth pushbutton or Bluetooth module is connected and activated only to the master drive. Its opening command is not passed on to the slave drive and only the traffic leaf opens.
- 2 A rotary switch is connected to the input E3 of the master or slave drive. For the master and slave drive, the "Day/night switchover" function is assigned to input E3. A pushbutton is connected to input E4 of the master or slave drive. For the master drive, the function 'Opening pulse (day + night)' is assigned to input E4. For the slave drive, the function 'Opening pulse (day)' is assigned to input E4.

This results in the following function of the rotary switch:

Day: both leaves are opened

Night: only traffic leaf is opened

4.6.5.4 Shot bolt of stationary leaf:

If the stationary leaf has a shoot bolt that must be opened electrically and independently of the traffic leaf lock, the potential-free output from the slave drive can be used for this purpose. The electrical diagram does not provide for this and must be adapted accordingly for the specific system.

4.6.6 Commissioning airlock door (wired)

A double door airlock, each door with a door operator, can be interconnected and interlocked to ensure that only one door of the airlock is open at any one time.

The two doors can be opened and closed in controlled relation to each other. For this purpose, the door positions can be defined at which mutual interlocking is activated or cancelled.

The corresponding electrical diagram including the default parameters can be found on the homepage in the download area.

Principle-scheme



Figure 30: Principle-scheme double door airlock

- 1 Remove the cover from both drives and switch off both drives.
- 2 The connecting cable between the two drives is laid and connected to both drives according to the electrical diagram (door 1 and door 2 signals).
- 3 Connect the lock to the respective drives per door according to the electrical diagram.
- 4 The push buttons for the opening signals are connected to both drives.
- 5 Optionally, a presence detector is connected to the drives (see Service Tool operating instructions).

IMPORTANT: The correct parameters of the sensor must be set according to the electrical diagram.

INFO: Drive continues to run in LOW-ENERGY mode

- 6 The two drives are switched on and the covers are replaced.
- 7 Use the Service Tool to set the parameters for the lock in use.
- 8 Use the Service Tool to set the parameters for the inputs according to the application.
- 9 Use the Service Tool to set the parameters for mutual interlocking. The positions of the mutual interlocking must be adapted to the application and tested in the process



NOTICE

The default parameters on the electrical diagram only serve as an example. The positions of the mutual interlocking must be adapted to the application and tested.



WARNING

Incorrectly set parameters for the positions of mutual interlocking can lead to malfunction of the double door airlock.

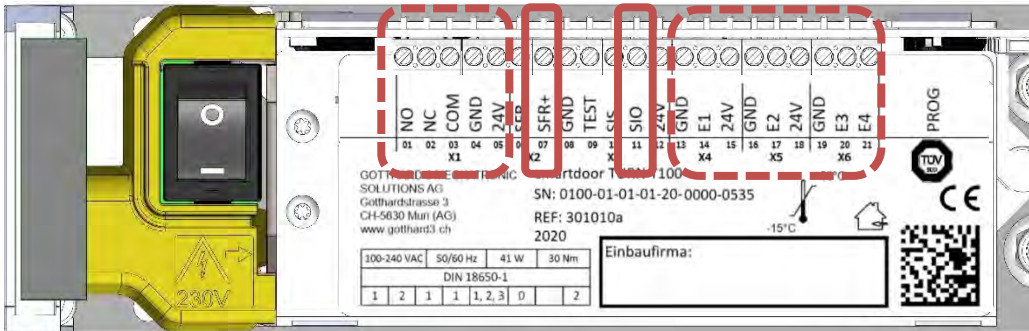

Figure 31: Connecting terminals for double door airlock

X1.01	NO	Programmable relay	Output: NO
X1.02	NC		Output: NC
X1.03	COM		Input: COM with 0-125 VAC/DC, 1 A
X1.04	GND		GND ¹⁾
X1.05	24 V		VDC 1: Short-circuit-proof
X2.06	(DIO)	Freely programmable in / output	Inverted signal of DIO
X2.07	DIO		Digital I/O
X3.08	GND	Safety elements	GND ¹⁾
X3.09	TEST		Output: Test signal +24 VDC
X3.10	SIS		Input: Safety when closing
X3.11	SIO		Input: Safety when opening
X3.12	24 V		VDC 2: Not short-circuit-proof
X4.13	GND	Function is set via Service Tool. Default: Opening pulse (Day+Night)	GND ¹⁾
X4.14	E1		Input 1: Floating contact
X4.15	24 V		VDC 3: Short-circuit-proof
X5.16	GND	Function is set via Service Tool. Default: Opening pulse (Day+Night)	GND ¹⁾
X5.17	E2		Input 2: Floating contact
X5.18	24 V		VDC 4: Short-circuit-proof
X6.19	GND		GND ¹⁾
X6.20	E3	Function is set via Service Tool. Default: Day/Night switch-over	Input 3: Floating contact
X6.21	E4	Function is set via Service Tool. Default: Opening pulse (Day)	Input 4: Floating contact

Table 10: Connecting terminals for double door airlock

4.6.6.1 Mutual interlocking:

Door 1 has the option of locking door 2 to ensure that door 2 can no longer open. Closing of door 2 is always possible.

Likewise, door 2 has the option of locking door 1 to ensure that door 1 can no longer open. Closing of door 1 is always possible.

In both doors the locking is activated during the whole opening cycle, it is released only when the door is closed and it is realized by setting the signal SIO (protection during opening).

In the electrical diagram, the area of the interlock is marked as the "OPEN" area.

4.7 Escape doors

Because of the small opening forces involved in manual door opening, the door drive is often used on an escape door.

A legally required escape suitability must be guaranteed by means of components provided for this, such as a mechanical panic function of the lock or a suitable escape terminal. The door drive must not be part of an escape route concept.

The manufacturer of the automatic door system must ensure that

- the legally required forces for opening the escape door are complied with
- other legally required functions are fulfilled
- the door drive cannot have any influence on the legally required functions

This list should only serve as a reminder with the most important points, it is not exhaustive and may vary depending on local legislation.



NOTICE

The door drive must not be part of an escape route concept; the suitability for escape must be implemented with the components provided.

4.8 Fire doors

The smartdoor TURN T100 was tested for fire protection suitability.

A legally required closing or opening of the door is realized through the use of an uninterruptible power supply designed for this purpose. The locally applicable legislation decides whether this is allowed on this fire door or not.

The design of the uninterruptible power supply and the possible closing or opening of the door is part of the entire automatic door system and must be ensured by the manufacturer of the automatic door system.

The manufacturer of the automatic door system must ensure that

- a legally required closing or opening of the door in case of fire is guaranteed
- the operating mode "permanently open" cannot be selected
- opening signals in the event of fire are properly interrupted or prevented by a fire alarm system provided for this purpose
- other legally required functions are fulfilled
- the door operator cannot have any influence on the legally required functions.

This list should only serve as a reminder with the most important points, it is not exhaustive and may vary depending on local legislation.



NOTICE

The door operator has no mechanical closing or opening function. A legally required closing or opening of the door can only be realized by using an uninterruptible power supply. The locally applicable legislation decides whether this is allowed on this fire door or not.

5 Functions

5.1 Automatic switch-on function after power failure

In the event of power failure, the door remains in the current position. In the closed state the door is held in position with the patented unpowered closing torque.

In the event of power failure the door latch can be actuated with a manual force of max. 67 N and the door can be opened with a manual force of max. 90 N.

After a current interruption the door operator starts in initialisation MODE.

In this state, all operating and safety elements are deactivated and the drive starts to approach its closed position.

If the initialisation is successful, the drive acknowledges the error, switches to the last selected operating mode and is once more ready for operation.



NOTICE

After a current interruption the door operator automatically travels to the closed position and switches to the last selected operating mode. After this, the drive is ready to operate once more.



WARNING

The door operator can move the door automatically after a current interruption to the closed position.

5.2 Automatic troubleshooting function

In the event of an error the door remains in the current state, switches to system error MODE and indicates this with 10 beeps and a red flashing LED.

The drive then switches to the initialisation MODE.

In this state, all operating and safety elements are deactivated and the drive starts to approach its closed position.

If the initialisation is successful, the drive acknowledges the error, switches to the last selected operating mode and is once more ready for operation.

If an error cannot automatically be remedied by the door operator it remains in system error MODE. Press and hold the MODE key (5 seconds) to carry out a manual RESET and remedy the error (see also 7.3 Manual RESET of an error).

5.3 Auto-Learning function

The commissioning of the drive is carried out with the help of the Auto-Learning function. The drive learns the door's physical characteristics and adjusts the values for the LOW-ENERGY mode. In addition, the most important parameters are automatically recognised and the holding force is set.

The Auto-Learning function can be triggered in two ways:

- With the Service Tool
- With the PROG push button on the control



NOTICE

In Auto-Learning mode, the drive learns about the door and its environment. This chapter or the Service Tool provide instructions for the installer.

The drive uses the Auto-Learning function to automatically detect:

- Direction of rotation of the doors
- Open and closed positions
- Linkage type (slider or scissor linkage)
- Inertia of the door leaf
- Maximum permitted opening and closing times for LOW ENERGY
- Connected safety sensors (SIO, SIS)
- Wall blanking at SIO
- Opening force
- Closing force
- Electric door opener (release delay)

5.3.1 Prerequisites

- The latch clip is employed, depending on the holding method (see chapter 3.4 Holding variants) and prevents the door latch lock from engaging
- An electric door opener or a motor lock must have been connected to the door operator and correctly set, see 4.5 Commissioning operating elements

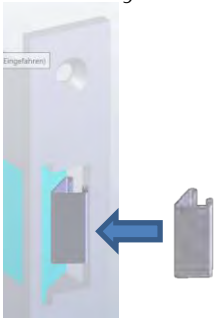

Figure 32: Latch clip



WARNING

Danger of trapping fingers when the output shaft is rotating: the spring integrated into the door operator generates a rotation force on the output shaft within a range of +/-15° to the closed door position. This applies also in the currentless state.

5.3.2 Implementation of the Auto-Learning function (with PROG key)

See also flow chart in the appendix, chapter 11.7 PUSH button template.

- 1 Dismantle cover from the drive
Switch off door operator (Power OFF)
Bring door leaf to the closed position
Switch on door operator (Power ON)
- 2 Within 10 seconds, while the red LED is flashing, press the PROG key for 5 seconds to start the Auto-Learning function
The drive acknowledges the start of the Auto-Learning function with 2 beeps (short)
The drive acknowledges the closed position with 1 beep
- 3 Bring door leaf to open position and press PROG-button briefly
The drive acknowledges the OPEN position with 2 beeps
- 4 In the case of scissor linkage: Hold door leaf in OPEN position and press PROG key briefly
In the case of sliding linkage: Hold door leaf in CLOSED position and press PROG key briefly
The drive acknowledges the linkage type with 3 beeps
- 5 Hold door leaf in CLOSED position and press PROG key briefly
The drive acknowledges the concluded setting of the door position with 4 beeps (short, then continuously every 20 seconds)
If the door position setting cannot be correctly detected, you will hear 10 short beeps and you will need to repeat the process from step 2.
- 6 Move door leaf to a freely selectable position (approx. 20° open), so that the cylindrical head screw of the linkage is easily accessible and press PROG key briefly
The drive switches to braked mode and holds the door leaf in one place
The drive acknowledges the intermediate position with 1 beep (short, then continuously every 20 seconds)
- 7 Fix the door leaf in this position with the wedge supplied and loosen the cylindrical head screw of the linkage such that the drive shaft can rotate freely. Then press the PROG key briefly
The drive acknowledges the fixed door position and unfastened linkage screw with 2 beeps (short, then continuously every 20 seconds)
The drive rotates until the correct holding position has been found. This process lasts 1-2 minutes
- 8 Tighten linkage screw on drive shaft with torque wrench to 15 Nm
Remove the wedge and press the PROG key briefly
The drive acknowledges that the door leaf is detached with 3 beeps
If the spring force setting cannot be correctly detected, you will hear 10 short beeps and you will need to repeat the process from step 6.
- 9 The door operator now starts the Auto-Learning cycle. The door operator beeps at intervals of one second and the door leaf is opened and closed several times.
This process lasts approx. 2 minutes
- 10 If the Auto-Learning function detects all parameters, the function is completed successfully and the door operator travels towards the CLOSED position.
If an error occurs during the Auto-Learning function, you will hear 10 short beeps, there are no parameters stored and the process must be repeated from step 1
- 11 The cover can be replaced onto the door operator



WARNING

To guarantee safe operation, use the cylindrical head screw supplied with the with threadlocker (blue paint on thread) and tighten with the torque wrench to 15 Nm.



NOTICE

In the event of an error, rapid beeps will be emitted for 2 seconds. After this, repeat the current step.
 You can abort the Auto-Learning function at any time with Power-OFF.
 If the Auto-Learning function is not concluded successfully, the old parameters remain active.

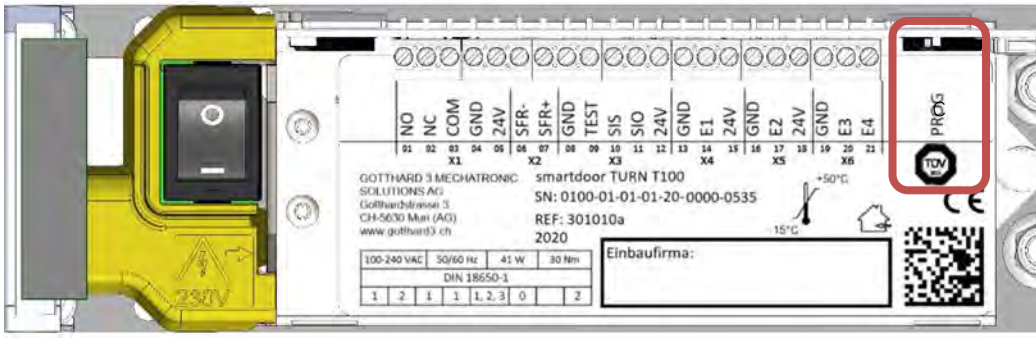

Figure 33: PROG key

5.4 LOW-ENERGY mode

The EN 16005 standard defines the LOW-ENERGY operating mode and allows a door operator to operate without safety elements without danger of injury. The smartdoor TURN targets precisely this application. With its Auto-Learning function it automatically calculates the necessary door parameters and makes easy work of commissioning.

This LOW-ENERGY mode is optimal for equipping disability-friendly homes and lightweight doors with a swing door operator anywhere in an interior.



NOTICE

The smartdoor TURN T100 consistently works in LOW-ENERGY mode and moves the swing door at reduced travel speeds according to the safety requirements of DIN 18650, EN 16005.
 In this, the door operator continuously monitors the speed so that the swing door never exceeds the maximum kinetic energy of 1.69 J. This maximum kinetic energy is related to the mass and width of the door leaf. This results in maximum opening times as given in Table 12: Area of use and opening times in LOW-ENERGY operation.

5.5 Functions of inputs and outputs

In the case of the smartdoor door operator the functions can be assigned to inputs and outputs as required.

The Table 14: Assignment of function to inputs and outputs lists in a matrix which functions are available at which inputs and outputs. Functions, inputs and outputs in grey are not yet available and will be released with future updates.

5.5.1 SIO: Safety sensor Opening

This function is permanently assigned to the SIO input.

A presence sensor (e.g. active infrared-light sensor or scanner) can be connected and serves to secure the swing range of the door in the opening direction. The sensor is usually attached on the hinge side of the door to the door leaf and triggers a STOP pulse.

Afterwards, the door behaves exactly as it would when it encounters an obstacle when opening.

LOW-ENERGY mode

If a presence sensor is connected, the door operator continues in LOW-ENERGY mode.

5.5.2 SIS: Safety sensor Closing

This function is permanently assigned to the SIS input.

A presence sensor (e.g. active infrared-light sensor or scanner) can be connected and serves to secure the swing range of the door in the closing direction. The sensor is usually attached to the opposite hinge side of the door onto the door leaf and triggers a REOPEN pulse.

Afterwards, the door behaves exactly as it would when it encounters an obstacle when closing.

LOW-ENERGY mode

If a presence sensor is connected, the door operator continues in LOW-ENERGY mode.

5.5.3 Opening pulse (Day+Night)

This function can be assigned to all inputs.

This function triggers a door opening under specific conditions.

In this case the delay time VZ must expire before the door opens.

If there is a continuous signal at this input, the door remains open until all conditions are fulfilled.

Condition for door opening:

- (input at GND) & (delay time expired)

5.5.4 Opening pulse (Day+Night) + lock feedback

This function can be assigned to all wired inputs.

This function triggers a door opening without any further conditions.

The door opens immediately; any delay time is interrupted.

If there is a continuous signal at this input, the door remains open until all conditions are fulfilled.

Condition for door opening:

- (Input at GND)

5.5.5 Opening pulse (Day)

This function can be assigned to all inputs.

This function triggers a door opening under specific conditions.

If there is a continuous signal at this input, the door remains open until all conditions are fulfilled.

Condition for door opening:

- (Input at GND) & (Day/Night switch-over = Day) & (delay time expired)

5.5.6 Day/Night switch-over

This function can be assigned to all wired inputs.

This function switches between day and night mode. This can be implemented with the use of a key switch, rotary switch, timer or any other floating contact.

It is recommended also that the Day/Night switch-over is used for the day mode of a motor lock. Corresponding electrical diagrams are available.

Example, day mode:

- A radar or push button, which is typically mounted on the outside of the door and is connected to an input with the function "Opening pulse (Day)", is enabled in day mode.

Example, night mode:

- A radar or push button, which is typically mounted on the outside of the door and is connected to an input with the function "Opening pulse (Day)", is disabled in night mode.

5.5.7 Lock feedback

This function can be assigned to all wired inputs.

This function interrupts a delay time which has begun and enables a pre-existing opening command.

If a continuous signal is applied to this input, this command is permanently enabled.

Condition for door opening:

- (Input at GND) & (existing opening command)

5.5.8 MODE switch-over

This function can be assigned to all inputs.

This function effectively switches over the operating mode.

A detailed description of the operating mode can be found in chapter 6 Operating mode.

5.6 Closing sequence control function

The closing sequence control is used for a door with two door leaves, each of which is equipped with a door operator. The two door leaves can be opened and closed in relation to each other in a controlled manner. For this purpose, the door positions at which a mutual interlocking is activated or cancelled can be defined.

The drive on the traffic leaf acts as a master and is responsible for unlocking the lock, can accept all available opening signals and supports the common presence sensors.

The drive on the stationary leaf acts as a slave, can accept all available opening signals, forwards them to the master and supports the usual presence sensors.

5.7 Airlock door function

A double door airlock, each door with a door operator, can be interconnected and interlocked to ensure that only one door of the airlock is open at any one time.

For both doors, the interlock is activated during the entire opening cycle and is only released again when the door is in the closed position

6 Operating mode

The smartdoor TURN knows the following operating modes:

- Automatic: All operating and safety elements are active
- Continuously open: The door remains open until the operating mode is changed
- Initialisation: The door travels to the closed position and is locked
- Auto-Learning: The door operator is in this operating status during the Auto-Learning process
- System error: In the event of a system error the door operator switches to this operating status

Trigger for MODE switch-over (trip command)

- MODE button on the communication module
- smartdoor Bluetooth push button
- smartdoor Bluetooth module
- smartdoor APP
- Service Tool

A detailed description of the switch-over of the operating mode is given in chapter 7.4.1 Switch-over of the operating mode.

6.1 Automatic operating mode (LED: green)

In this operating mode the door opens under all the trip commands listed below within the pre-set opening time, remains open for the pre-set hold-open time and then closes within the preset closing time.

Trigger for door opening (trip command)

- Push&Go
- smartdoor Bluetooth push button
- smartdoor Bluetooth module
- smartdoor APP
- Input E1, E2, E3 or E4: Opening pulse (Day+Night)
- Input E1, E2, E3 or E4: Opening pulse (Day + Night) + lock feedback
- Input E1, E2, E3 or E4: Opening pulse (Day)

Functionality

- Push&Go function, with wind gust detection
- Low-energy
- Closing sequence control for 2-leaf doors
- Airlock: two or more successive, mutually interlocked doors
- Automatic detection of safety elements
- Adaptive opening speed (vandalism protection)
- Situational obstacle detection when opening/closing
- Unpowered closing torque in the closed position

Configuration and operation by smartdoor APP

- Open
- Operating mode selection
- Hold-open time
- Opening time (>3 seconds)
- Closing time (>3 seconds)
- Closing force (<67 N)
- Angle correction OPEN position

Push&Go or gust

The door differentiates between a Push&Go pulse and wind gust.

The door has a sensitive Push&Go response so that children or elderly people can operate the door in this way. You can adjust the sensitivity of the Push&Go pulse via the Service Tool.

A static wind pressure or wind gust is detected and does not cause the door to open. In the holding version "Door handle with disabled latch" the door operator can, if required, ensure the closed position with a current feed to the soft lock.

A static wind pressure or wind gust is also detected at closure and activates an automatic, incremental increase of the closing force.

Adaptive opening speed

During opening, the door responds to pressure or pulling by the operator such that the door operator surrenders the door control to the operator. As soon as the interaction by the operator is interrupted, the door re-assumes control.

Obstacle detection

There is differentiation between obstacles when opening and obstacles when closing. In the shear and crushing point area, the obstacle detection is more sensitive than in other positions.

Behaviour - obstacle when opening

The behaviour in the case of an obstacle when opening can be set using the Service Tool.

Settings:

Behaviour in the case of an obstacle: stop or reverse

Number of attempts: 0-10

Behaviour - obstacle when closing

The behaviour in the case of an obstacle when closing can be set using the Service Tool.

Settings:

Behaviour in the case of an obstacle: stop or reverse

Extension of the hold-open time and maximum hold-open time

Number of attempts: 0-10

6.2 Operating mode - continuously open (LED: flashing green)

The door opens and remains open until the operating mode changes or the door is closed with a Push&Go.

Trigger for door opening (trip command):

- MODE button
- smartdoor Bluetooth push button
- smartdoor Bluetooth module
- smartdoor APP

Functionality

- Continuously open

6.3 Operating status initialisation (LED: flashing orange)

At initialisation, no operating mode is active. All operating and safety elements are deactivated.

Trigger

- Power-ON
- Automatic troubleshooting
- Press and hold MODE button for 5 seconds

Functionality

- The initialisation is indicated by 3 short beeps.
The drive then starts to move to its closed position.
Once reached, the drive acknowledges all impending errors and switches to the last selected operating mode.



NOTICE

If the door operator was in Continuously Open MODE before a power failure, the Continuously Open MODE is restored at Power-ON after successful initialisation.

6.4 Auto-Learning operating status (LED: flashing red/orange)

There is no active operating mode in the Auto-Learning function. All operating and safety elements are deactivated.

Trigger

- Service Tool
- After Power ON press and hold down the PROG key for 5 seconds

Functionality

- The Auto-Learning function is described in chapter 5.3 Auto-Learning function.

6.5 System error operating status (LED: flashing red)

In the case of a system error no operating mode is active. All operating and safety elements are deactivated.

Trigger

- None

Functionality

- None

7 Operation

7.1 Main switch

In order to actuate the main switch the housing is removed. The main switch is located on the opposite side of the MODE push button and is easily accessible on the top (see Figure 34: Main switch).

With the main switch the connection voltage and all further auxiliary voltages within of the door operator are switched off.

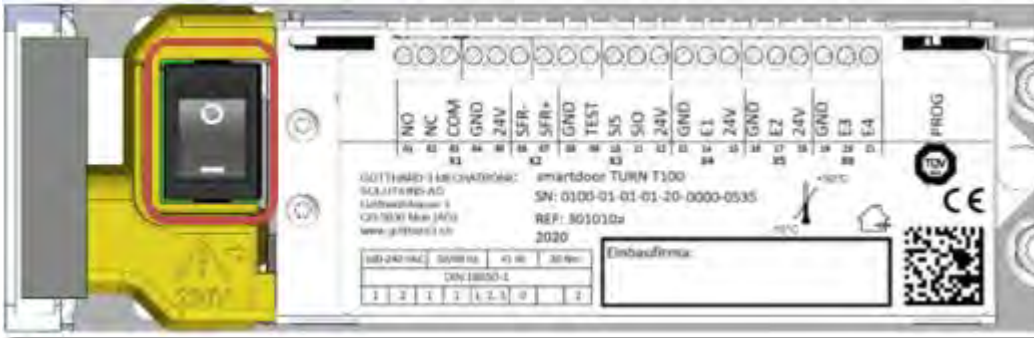

Figure 34: Main switch



WARNING

Only after switching off the main switch may an expert work with an open door operator.

7.2 Setting the hold-open time

The hold-open time can be set using the MODE key of the communication module or the smartdoor APP (see chapter 7.5.5 Door control).

The hold-open time must be set to between 5 and 10 seconds.

7.2.1 Process

- 1 With the MODE button switch to the Continuously Open operating mode (see 7.4.1 Switch-over of the operating mode)
- 2 Door opens and remains in the open position
- 3 Press MODE push button for 5 seconds until a long beep sounds
- 4 Wait for the desired hold-open time. You will hear a beep sounded at second intervals
- 5 Press and release MODE push button after the desired hold-open time
- 6 Door closes and the programming is concluded

7.3 Manual RESET of an error

In the event of an error the door remains in the current state, switches to system error operating mode and indicates this with 10 beeps and a red flashing LED. In this state, all operating and safety elements are deactivated.

If an error cannot be automatically remedied by the door operator (see chapter 5.2 Automatic troubleshooting function), press and hold the MODE key (5 seconds) until a RESET is carried out.

In this case the drive switches to initialisation MODE and starts to approach its closed position. Once here, the drive acknowledges the error, switches to the last selected operating mode and is once more ready for operation.

If the error remains, call an expert technician.

7.3.1 Process

Press MODE button for 5 seconds until 1 long beep sounds, then release the MODE button. This carries out a RESET.

7.4 Switching over the operating mode

The smartdoor TURN knows the following operating modes:

- Automatic: All operating and safety elements are active
- Continuously open: The door remains open until the operating mode is changed
- Initialisation: Operating status during initialisation
- Auto-Learning: Operating status during the Auto-Learning function
- System error: Operating status during which a system error applies

7.4.1 Switch-over of the operating mode

You can switch between the operating modes of the smartdoor TURN using the MODE button on the communication module, the smartdoor Bluetooth push button, the smartdoor Bluetooth module or the smartdoor APP. This means it is possible to switch quickly from Automatic mode to Continuously Open and back.



Figure 35: Switch-over operating mode

More operating modes can be activated as required with the smartdoor APP. Switching over the operating mode means that the released operating modes are actuated in turn. In this case the LED lights up with the respectively selected operating mode.

The prevailing operating mode is always displayed. In this case the LED is lit in the corresponding colour of the operating mode:

- Automatic: green
- Continuously open: flashing green
- Initialisation: flashing orange (not available)
- Auto-Learning: flashing red/orange (not available)
- System error: flashing red (not available)

If the MODE button is actuated one more time the operating mode switches to the next state. The LED is lit in the corresponding colour. The MODE button is actuated until the desired operating mode is set.

7.5 smartdoor APP

With the smartdoor APP, the owner of smartdoor door operators can correspondingly adjust the most important parameters according to their requirements.

In the process, the limit values are automatically adapted to the door configuration. It is therefore for example not possible to set the opening or closing speed faster than the value specified in LOW ENERGY.



NOTICE

No personal data or values are stored in the smartdoor APP



7.5.1 Symbols

The following symbols are used in the smartdoor APP:

Button:		Active		Inactive
Command:		On		Off
Menu:				
Bluetooth connection:		Active		Inactive
Editing:		Active		Inactive
Value display:		adjustable		Display only
Selection:				
Clear:				
Disabled:				

Table 11: smartdoor APP symbols

7.5.2 Main menu - My doors

This screen is displayed when you start the APP. It contains a list of all connected door operators.

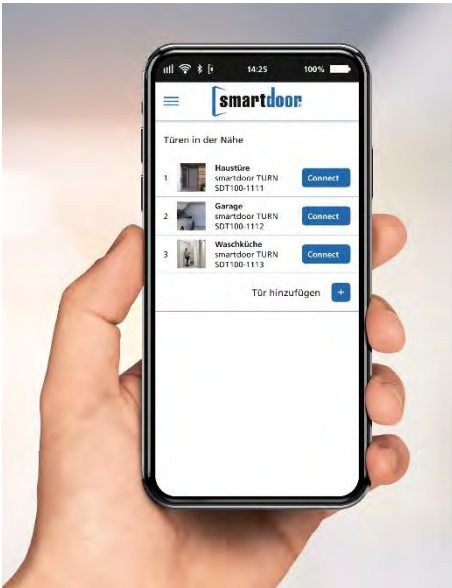

Figure 36: Main menu – My Doors screen

7.5.3 Connect new door operator in the APP

The "Add door" command in the "My Doors" screen takes you automatically to your smartphone's Bluetooth menu in order to pair the two devices via the Bluetooth-connection.

- 1 In the "My Doors" screen, select the "Add door" command
- 2 You are automatically taken to the smartphone's Bluetooth menu and a search is made for new Bluetooth devices. These are typically shown in list form.
- 3 Press the BLUETOOTH button on the door operator (see chapter 4.5.1.1 Addition of Bluetooth operating elements) to display the smartdoor door operator for 15 seconds for the other Bluetooth devices.
- 4 The smartdoor door operator appears in the scan list with its unique serial number, which is printed on the type plate.
If within 15 seconds this does not happen, repeat step 3 or, if necessary, switch the Bluetooth service off and on again on your smartphone.
- 5 Select the smartdoor door operator in the Bluetooth scan list to pair it with your smartphone.
- 6 Switch in your smartphone back to the smartdoor APP. In the "My Doors" screen, the door operator is now shown in the list.



NOTICE

If this door operator is connected to the APP for the first time, operation with the smartphone is NOT enabled. A password must be entered first.

7.5.4 Password for release of a smartphone

The password is requested the first time you connect with the smartdoor door operator.

- 1 In the "My Doors" screen, select the "CONNECT" command for the corresponding door
- 2 A pop-up screen appears, in which you need to enter the password. Press "Confirm" to check the password.
- 3 If the password is correct, "Door Control" appears on the screen. If not, click on "My Doors" to return to the main menu.

7.5.5 Door control

The "Door Control" screen is divided into three sections. The door operator can be used to adapt the most important settings to your own preferences and call up information.

First section:

The door can be opened with the "OPEN" button.

A MODE switch-over can be triggered.

A photo can be added to the door for better recognition.

Second section "Settings":

In this case the most important settings can be adapted to customer requirements.

In the process, the limit values are automatically adapted to the door configuration. It is therefore for example not possible to set the opening or closing speed faster than the value specified in LOW ENERGY.

Third section "Service information":

The most important information is displayed here.

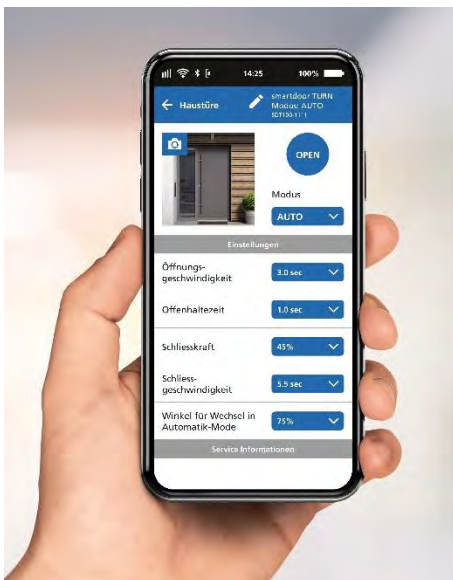

Figure 37: Door control screen

7.5.6 User manual / FAQ

In this screen the user manual and other helpful documents are displayed. For this an APP which can display PDF documents must have been installed on the smartphone. The most recent versions of the documents are always shown. The prerequisite for this is an active Internet connection.

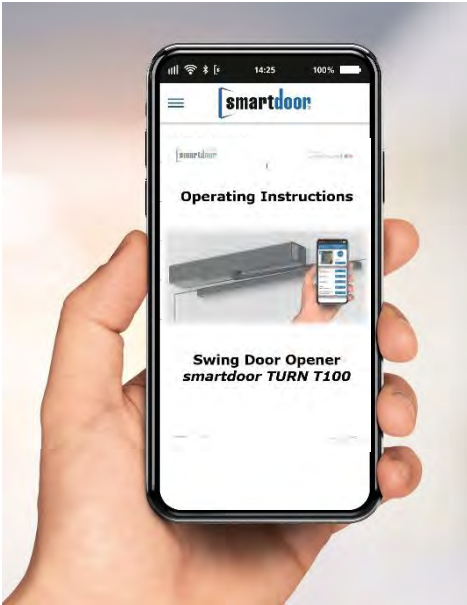

Figure 38: User manual / FAQ screen

8 Service

8.1 Care / operator checks

8.1.1 Switch off

Switching off is explained in chapter "7.1 Main switch".

8.1.2 Checks

The operator must carry out checks 1x monthly or if an error occurs or in the event of abnormal noises.

In this case the following functions must be checked:

- Make sure that the automatic operating mode is switched on.
 - Open with all connected operating elements
 - If safety elements are connected, these trip during opening (SIO) or closing (SIS), so that the door stops.

8.1.3 Care

Only clean the product when the supply voltage is disconnected. Use a damp cloth and standard commercial cleaning agent.



NOTICE

The operator can use the corresponding "Operator checks" checklist (see inspection book) for product checking.



WARNING

If an error occurs, the door operator must be switched off and customer service immediately informed.

8.2 Maintenance / inspection by trained specialist personnel

When safety elements are connected, annual services must be carried out by trained specialist personnel.

Only then can it be ensured that potential errors or risks are detected in good time and the operator is informed accordingly.



NOTICE

Specialist personnel carry out the maintenance corresponding to the "Service" checklist (see inspection book).

9 Troubleshooting

9.1 Reset

In the event of an error the door remains in the current state which is indicated by a continuous beep.

If an error cannot be automatically remedied by the door operator (see chapter 5.2 Automatic troubleshooting function), press and hold the MODE key (approx. 10 seconds) until a RESET is carried out.

If the error remains, call an expert technician.

9.1.1 Process

Press MODE button for 10 seconds until 1 long beep sounds, then release the MODE button. This carries out a RESET.



Figure 39: Press the MODE button 10 seconds to carry out a RESET

10 Technical data

Service life

- Service life min. 500,000 cycles, 2400 cycles/day

Mechanical data

- Drive dimensions single leaf 400 x 52 x 72 mm (W x H x D)
- Closing force in accordance with EN 1154 EN3 (Sliding linkage)
EN4 (Scissor linkage)
- Max. torque 30 Nm
- Weight without linkage 2.4 kg
- Noise < 30 dB
- Opening angle adjustable, max. 115°
- Max. drive speed 40° per second
- Range of Closing function (unpowered) 5-15°
- Motor damping in front of the end stop 5-15°
- Hold-open time 5-10 seconds

Electrical data

- LOW-ENERGY drive according to EN 16005
- Suitable in fire for doors according to EN 16034
- Classification of self-closing in case of fire C5 *
* in combination with battery, tested with 500,000 test cycles
- Connection voltage AC version: 100-240 VAC, 50/60 Hz
DC version: 22-28 VDC, 6 A
- Power supply for external sensors/devices 24 VDC, 0.8 A
- Power consumption, rated power 41 W
- Power consumption, standby < 1 W
- Protection class IP20

Ambient conditions

- Temperature range -15 °C to +50 °C
- Relative humidity < 85 %, non-condensing

Assembly data

- Width of the door leaf 600 - 1200 mm (sliding linkage)
600 - 1200 mm (scissor linkage)
- Door weight Max. 100 kg (sliding linkage)
Max. 120 kg (scissor linkage)

10.1 Area of use and opening times in LOW-ENERGY operation

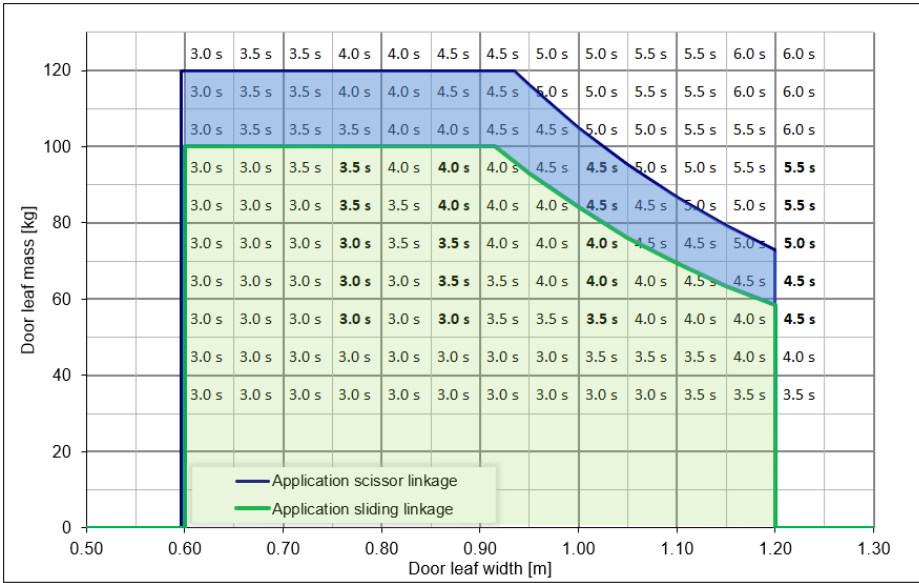

Table 12: Area of use and opening times in LOW-ENERGY operation

11 Appendix

11.1 Connecting terminals

X1.01	NO	Programmable relay	Output: NO
X1.02	NC		Output: NC
X1.03	COM		Input: COM with 0-125 VAC/DC, 1 A
X1.04	GND		GND ¹⁾
X1.05	24 V		VDC 1: Short-circuit-proof
X2.06	(DIO)	Freely programmable in / output	Inverted signal of DIO
X2.07	DIO		Digital I/O
X3.08	GND	Safety elements	GND ¹⁾
X3.09	TEST		Output: Test signal +24 VDC
X3.10	SIS		Input: Safety when closing
X3.11	SIO		Input: Safety when opening
X3.12	24 V		VDC 2: Not short-circuit-proof
X4.13	GND	Function is set via Service Tool. Default: Opening pulse (Day+Night)	GND ¹⁾
X4.14	E1		Input 1: Floating contact
X4.15	24 V		VDC 3: Short-circuit-proof
X5.16	GND	Function is set via Service Tool. Default: Opening pulse (Day+Night)	GND ¹⁾
X5.17	E2		Input 2: Floating contact
X5.18	24 V		VDC 4: Short-circuit-proof
X6.19	GND		GND ¹⁾
X6.20	E3	Function is set via Service Tool. Default: Day/Night switch-over	Input 3: Floating contact
X6.21	E4	Function is set via Service Tool. Default: Opening pulse (Day)	Input 4: Floating contact

¹⁾ All GND have the same potential

Table 13: Connecting terminals

11.2 Assignment of function to inputs and outputs

Function:	Input:									
	Input E1	Input E2	Input E3	Input E4	Input / Output (DIO)	SIO	SIS	Bluetooth push button	Bluetooth module T1	Bluetooth module T2
SIO: Safety sensor Opening	-	-	-	-	-	OK	-	-	-	-
SIS: Safety sensor Closing	-	-	-	-	-	-	OK	-	-	-
Opening pulse (Day+Night)	OK	OK	OK	OK	-	-	-	OK	OK	OK
Opening pulse (Day+Night) + RR	OK	OK	OK	OK	-	-	-	-	-	-
Opening pulse (Day)	OK	OK	OK	OK	-	-	-	OK	OK	OK
Day/Night switch-over	OK	OK	OK	OK	-	-	-	-	-	-
Lock feedback	OK	OK	OK	OK	-	-	-	-	-	-
MODE switch-over	OK	OK	OK	OK	-	-	-	OK	OK	OK
Closing sequence control	-	-	-	-	OK	OK	OK	-	-	-
Airlock door	-	-	-	-	OK	OK	-	-	-	-
SHEV open	OK	OK	OK	OK	-	-	-			
SHEV closed	OK	OK	OK	OK	-	-	-			
A posteriori (KEY)	OK	OK	OK	OK	-	-	-			
Manual operation ON/OFF	OK	OK	OK	OK	-	-	-			
Gong	OK	OK	OK	OK	-	-	-			
Step positioning device	OK	OK	OK	OK	-	-	-			
Deadman open	OK	OK	OK	OK	-	-	-			
Deadman closed	OK	OK	OK	OK	-	-	-			
Emergency stop	OK	OK	OK	OK	-	-	-			
Emergency open	OK	OK	OK	OK	-	-	-			
Emergency close	OK	OK	OK	OK	-	-	-			

Table 14: Assignment of function to inputs and outputs

11.3 Display LED and system error

11.3.1 Communication module

MODE LED	Beep signal	Description
Flashing orange	1x short, 3x long	Initialisation after Power-ON or after a RESET
green	-	MODE: Automatic
flashing green	-	MODE: Continuously open
flashing green/blue	-	Hold-open time is set
flashing red	10x short	System error
flashing red/orange	-	Auto-Learning
red/green/blue running light	-	Firmware update – communication module

Table 15: Display MODE LED

System LED	Beep signal	Description
off	-	Communication module is inactive
green	-	Communication module is active
flashing green	-	Initialisation after Power-ON or after a RESET or firmware update communication module is active

Table 16: Display system LED

Bluetooth LED	Beep signal	Description
off	-	Bluetooth is inactive
blue	-	Bluetooth is active
flashing blue	-	Bluetooth classic scan-mode active
flashing blue (rapid)	-	Bluetooth classic and BLE scan-mode active or firmware update communication module is active

Table 17: Display Bluetooth LED

11.3.2 Control module

Door LED	Beep signal	Description
off	-	Door is closed
yellow	-	Door is open (from opening angle 5 %)

Table 18: Display Door LED

Firmware LED	Beep signal	Description
off	-	Normal
flashing blue (rapid)	-	Error in firmware update, control module For troubleshooting, restart the drive with Power OFF / Power ON. The control system then starts in bootloader and waits for the firmware update.

Table 19: Display firmware LED

System LED	Beep signal	Description
off	-	Normal
flashing red	-	Initialisation after Power-ON

		or after a RESET
flashing red (rapid)	-	Firmware update, control module active
flashing red	10x short	System error see Table 21: System error

Table 20: Display system LED

System error	Description	Remedy
Display in smartdoor APP or Service Tool		
001	Short circuit detection in the 5 V-feed to the communication module	Communication module wire, board or connection defect
002	EEPROM Read/Write error detection	Control hardware defect (I2C, I/O-Expander, EEPROM)
003	I2C Bus error detection	Control hardware defect (I2C, I/O-Expander, EEPROM)
004	Encoder signal outside the tolerances, invalid	Encoder wire, board or connection defect
005	Current measurement offset too large	Control hardware defect
006	Expected current not measured	Motor wire or connection defect
007	12 V-feed for voltage modulation of drive cannot be controlled	Control hardware defect
008	Safety parameter comparison check invalid	Error RAM access in safety parameters Drive Power-OFF / Power-ON
009	Safety variable comparison check invalid	Error RAM access in safety variables
010	Error detection in speed monitoring	FW error, should not occur
011		
012	Auto-Learning: Error detection during door-mass detection	Door was blocked during Auto-Learning Execute Auto-Learning again.
013	Auto-Learning: LOW ENERGY speed invalid	Door was blocked during Auto-Learning Execute Auto-Learning again.
014	Auto-Learning: Error detection when fixing door linkage	Door not fixed correctly in Auto-Learning step 7. Execute Auto-Learning again.
015	Reserve	

201	IEC 60730 safety library: Tests Program Counter register for stuck at bits	Drive Power-OFF / Power-ON
202	IEC 60730 safety library: CPU core register tests	Drive Power-OFF / Power-ON
203	IEC 60730 safety library: Stack pointer corruption Detection	Drive Power-OFF / Power-ON
204	IEC 60730 safety library: Stack pointer corruption detected	Drive Power-OFF / Power-ON
205	IEC 60730 safety library: Illegal or invalid Instruction Detection	Drive Power-OFF / Power-ON
206	IEC 60730: Comparison Safety-Code invalid	Error RAM access in Safety-CODE / FLASH defect Drive Power-OFF / Power-ON

Table 21: System error

11.4 Construction Planner Template - Object overview

Construction planner: smartdoor TURN T100 - object overview

Company:

Commission:

Object:

Contact:

Configuration:

DIN left alu black white 7 15 30mm axle extension:
 DIN right latch clip RAL:

.....

.....

.....

.....

Application:

WC door
 passage door
 office door
 entrance door
 other

Option:

wall button hinge/entrance opposite hinge
 radar E:..... E:.....
 presence sensor SSO SSC
 electric door opener
 motor lock
 door stopper floor / sliding linkage / wall
 closing sequence

linkage type	scissor (max. 120kg)	sliding (max. 100kg)
lintel assembly	angle: max.110° lintel: -20/+200mm	angle: max.100° lintel: -20/+80mm
door leaf assembly	angle: max.110° overf.: -80/+80mm	angle: max.80° overf.: 0/+60mm
hinge opp. hinge	angle: max.100° overf.: -20/+100mm	angle: max.100° overf.: 0/+60mm

effective distances:
to ceiling:mm
dimension x:mm
dimension y:mm
dimension z:mm

For leaf mounting:
Minimum distance door leaf - wall: 72mm; effective distance:mm

göthard mechatronic solutions

Bauplaner smartdoor TURN T100 - Übersicht Objekt

Swing Door Operator

smartdoor TURN T100

311012_smartdoor_TURN_T100_Bauplaner.vsdX

Blatt 1/2

02.03.2021

Peter Kupferschmid

EN-English

11.5 Construction Planner Template - Electrical diagram

Construction planner: smartdoor TURN T100 - electrical diagram

Timing diagram showing pulse sequences for E2, E4, NO, and E1 inputs. It includes time intervals like Δt and $\Delta t=10s$.

Object:

Access control:
e-reader / code
Key switch
Button
Remote control
e.g. timer
Motion detector
e.g. IR sensor

Optional input:
BT button, BT module, Smartphone
[Icons: Smartphone, BT module, Push button, Motion detector]

PROG

E4	X6.21
E3	X6.20
GND	X6.19
24V	X5.18
E2	X5.17
GND	X5.16
24V	X4.15
E1	X4.14
GND	X4.13
24V	X3.12
SIO	X3.11
SIS	X3.10
TST+	X3.09
GND	X3.08
(DIO)	X2.07
(DIO)	X2.06
24V	X1.05
GND	X1.04
COM	X1.03
NC	X1.02
NO	X1.01

Einbaufirma:

100-240 VAC | 50/60 Hz | 41 W | 30 Nm
Drive unit for swing doors: EN16005; DIN 18650-1/-2

1	2	1	2,3	0	2
---	---	---	-----	---	---

GOTTHARD SOLLUTI
Gotthardstrasse 3
CH-5630 Muri (AG)
www.gotthard3.ch

REF: 301010a
2020

Parameter smartdoor TURN:

- = Closing force
- = Push&Go (on/off)
- = Push&Go sensitivity
- = Lock function (active/ina.)
- = Opening force
- = Delay time
- = Input E1
- = Input E2
- = Input E3
- = Input E4

= opening pulse (day + night)
= opening pulse (day + night)
= day/night operation
= opening pulse (day only)

Bauplaner smartdoor TURN T100 - Elektroschema

Swing Door Operator smartdoor TURN T100

311012_smartdoor_TURN_T100_Bauplaner.vsdX

Blatt 2/2

02.03.2021

Refer:
Kupferschmid

EN-English

11.6.2 Example electric door opener (master with release) v1

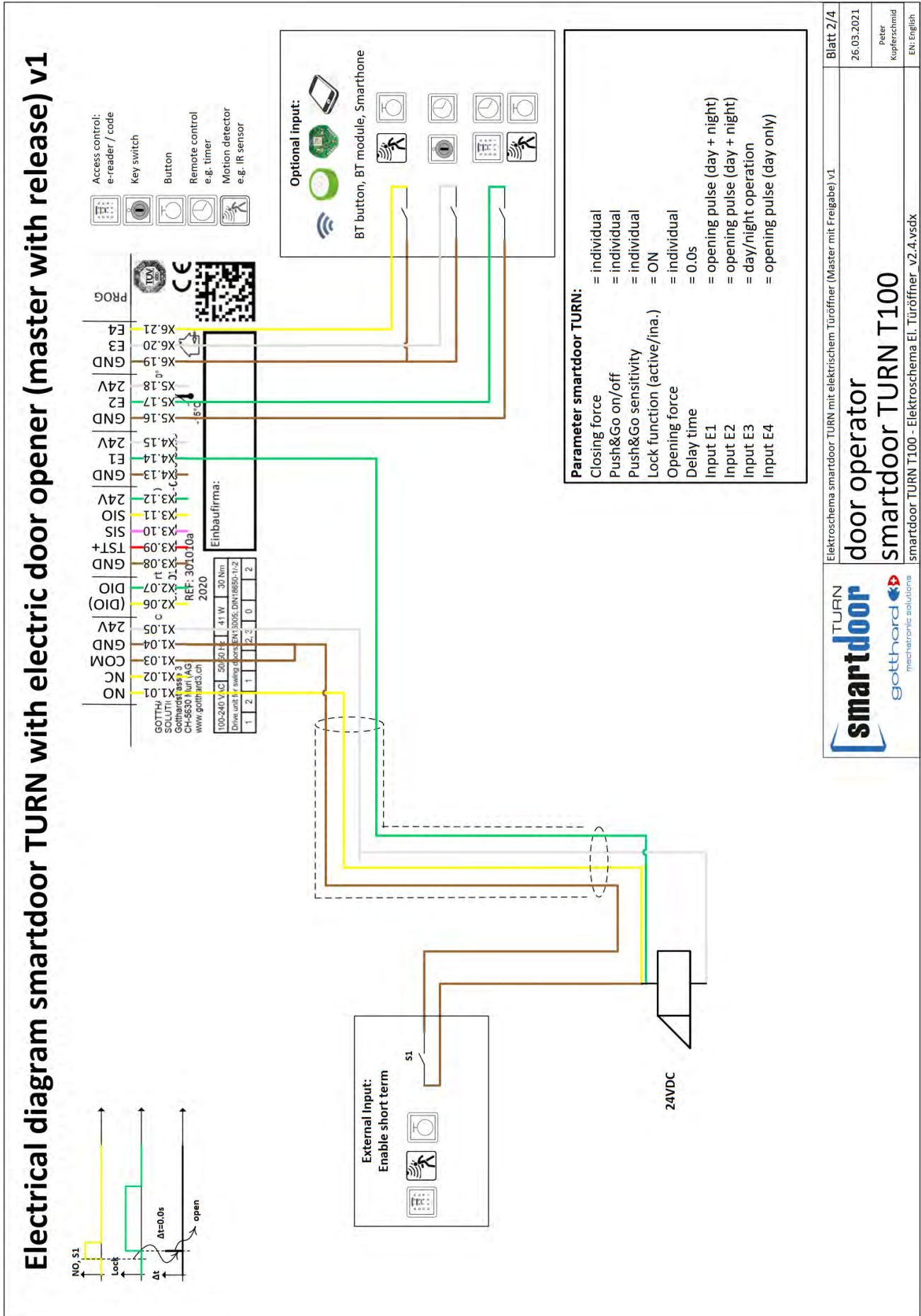

11.6.3 Example electric door opener (slave)

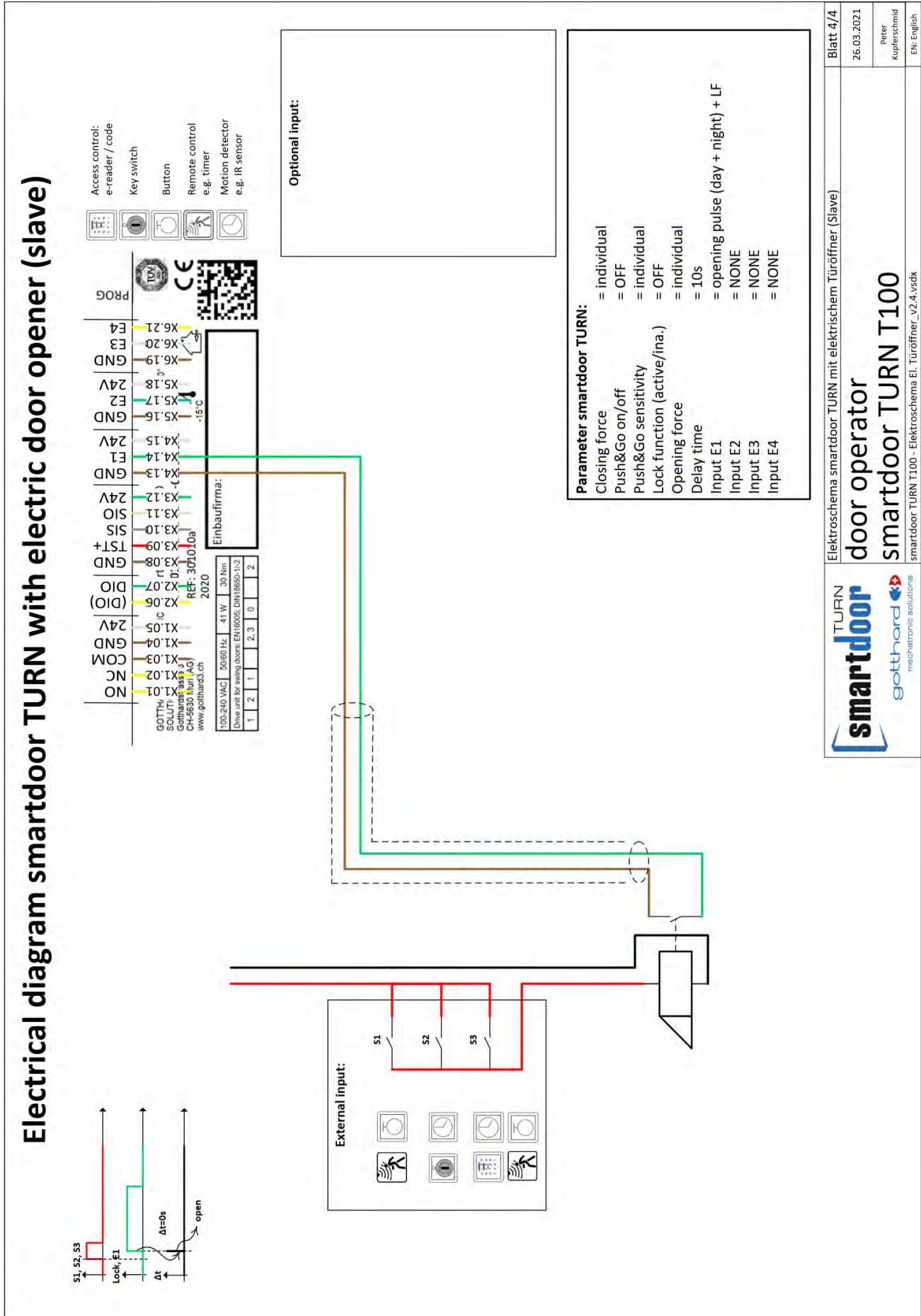

11.6.4 Example conversion of electric door opener with intercom system (DC)

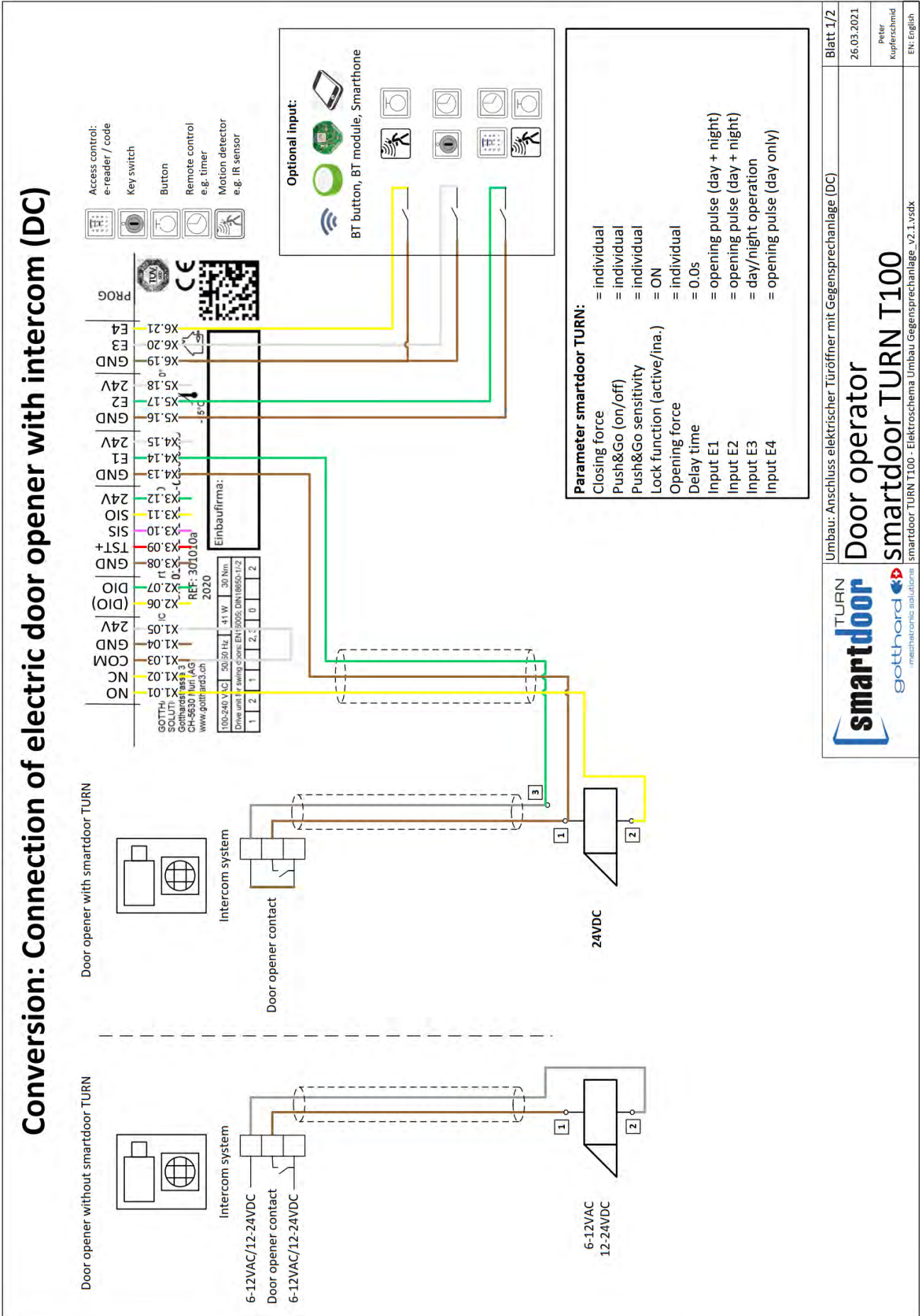

gottthard
mechatronic solutions

Umbau: Anschluss elektrischer Türöffner mit Gegensprechanlage (DC)

Door operator
smartdoor TURN T100
smartdoor TURN T100 - Elektroschema Umbau Gegensprechanlage_v2.1.vsd

Blatt 1/2

26.03.2021

Peter Kupferschmid

EN-English

11.6.5 Example motor lock (master-master)

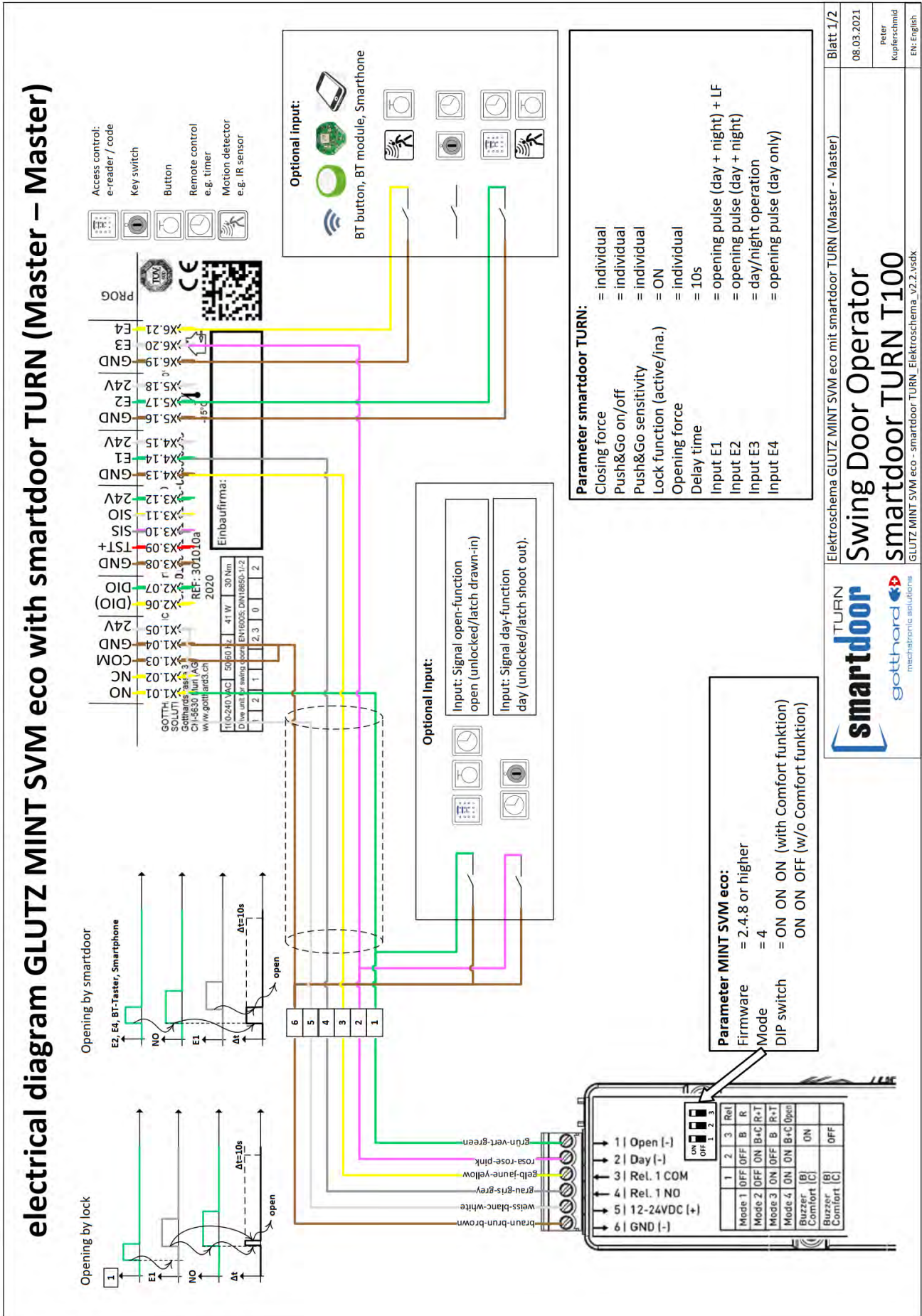

11.6.6 Example motor lock (master-slave)

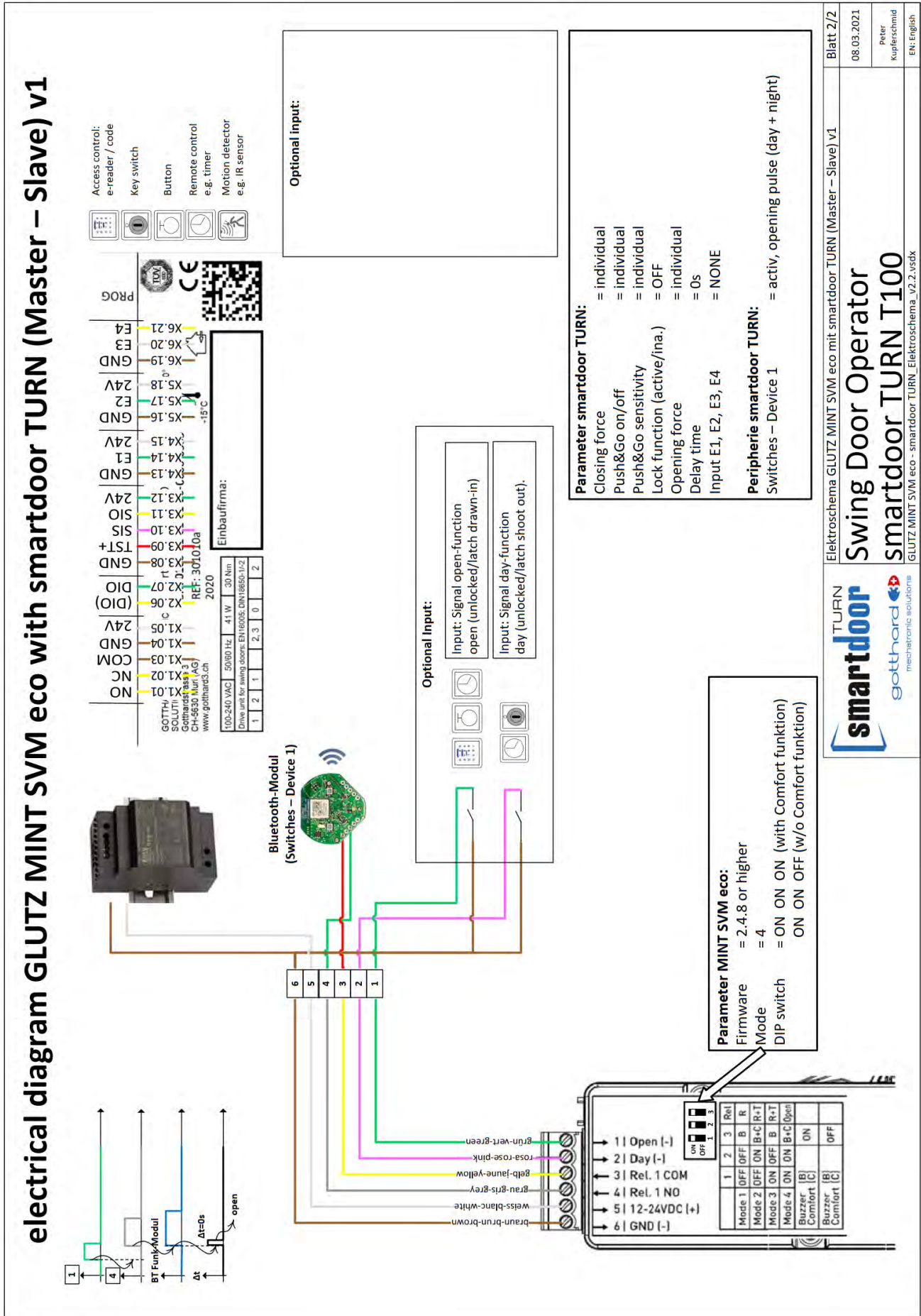

11.7 PUSH button template

More templates with the PUSH button are provided on the homepage in the download area.

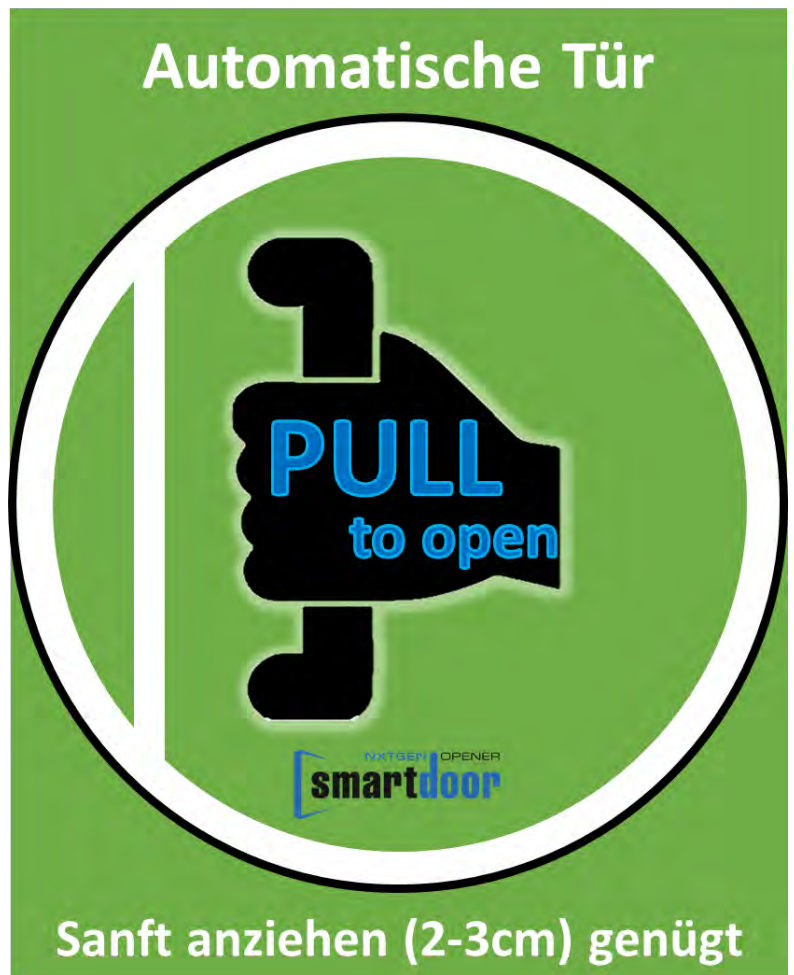

11.8 Auto-Learning function

